



# AIR Traffic

## Installation Manual

### Traffic Avoidance System

Document: MAN0070A0001  
Version: 4.5  
Date: 2022/12/05



Please read this manual carefully before installing the device.

Please observe the limitations and safety instructions.

This manual is an essential portion of the device and shall be kept in a safe place.

## Articles Covered

This manual covers the following articles:

- AT-1 "AIR Traffic", software version 5.

## Revision History

<i>Rev.</i>	<i>Date</i>	<i>Status</i>	<i>Author</i>	<i>Changes</i>	<i>Approved</i>
1.0	2018/08/29	Release	M. Förderer	Initial release	H. Hoeth
2.0	2018/10/25	Release	M. Förderer	Second release. Additional information and functions have been added.	–
2.1	2018/12/21	Release	M. Förderer	Added details regarding ARINC429 and discrete inputs	–
2.2	2019/03/15	Release	M. Förderer	Added ICA, fixed some minor issues	–
3.0	2019/03/15	Release	M. Förderer	Added details, updated configuration according to software version 5	–
4.0	2020/01/09	Release	M. Förderer	Added information regarding the latest software versions 7 and 8.	–
4.1	2020/12/09	Release	M. Förderer	Added information regarding the latest software version 14.	–
4.2	2021/06/29	Release	M. Förderer	Added information regarding the latest software version 15.	–
4.3	2021/07/15	Release	M. Förderer	Added information regarding the latest software version 16.	–
4.4	2021/12/20	Release	M. Förderer	Added information regarding the latest software version 22.	–
4.5	2023/12/05	Release	M. Förderer	Added information regarding the latest software versions 17/23.	–

## Product Support

If you have questions, our product support team will be happy to help you. Contact us via [support@air-avionics.com](mailto:support@air-avionics.com) or by phone. Please find details about our hotlines and availability online at <https://www.air-avionics.com>

# Contents

## General Description · 1

Introduction · 1

Equipment Description · 1

System Capabilities · 2

Technical Specifications · 2

Regulatory Compliance · 3

Liability · 5

Unpacking and Inspecting Equipment · 5

Installation Materials · 5

## System Interconnects · 7

D-SUB Power/Data Connectors · 7

USB Connector · 9

Antenna Connectors · 10

Static Pressure Port · 11

## Interfaces · 12

Serial Data Interface · 12

ARINC429 Interface · 13

WiFi Interface · 13

Data Bus Interface · 13

Power Supply and Enable Interface · 14

Audio Output · 16

Discrete Inputs · 17

## Installation Overview · 18

General Handling Recommendations · 18

Workmanship · 18

Cabling and Wiring Considerations · 19

Antenna Considerations · 20

Pressure Tubing Considerations · 27

AT-1 Mounting Considerations · 28

Compatibility Considerations · 29

Air Circulation and Cooling · 31

Compass Safe Distance · 31

## Installation Procedures · 32

Equipment Mounting · 32

Wiring · 35

Antenna Installation · 36

Interconnect Installation · 36

Post Installation Configuration, Checkout, and Documentation · 36

## Post Installation Checkout · 37

Wiring Checks · 37

Connector Engagement Checks · 37

## System Configuration · 38

AT-1 Configuration Webpage · 38

Simple, Advanced, and Expert Configuration Mode · 39

Simple Configuration · 40

Expert Configuration · 41

## Ground Checks · 42

Simulator for Ground Checks · 42

Interface Checkout · 42

Discrete Inputs Check · 43

Audio Check · 43

Version / Revision Check · 44

Traffic reception tests · 44

Failure Message Check · 44

## System Status and Error Messages · 45

Status LED · 45

AT-1 Status Information on Configuration Webpage · 49

## Configuration and Checkout Documentation · 51

Configuration Documentation · 51

Checkout Documentation · 51

## Maintenance · 52

Software Packages and Expiry · 52

Software/Database Loading · 52

## Bibliography · 54

## Assembly And Installation Drawings · 55

## Cabling and Configuration Examples · 56

GARMIN GTN 650 and 750 · 56

GARMIN GNS 430/530 (WAAS and non-WAAS versions) · 56

## Wiring Diagrams · 58

## Checkout Log · 60

Installation · 60

Ground Checks · 60

Interference Checks · 60

Documentation · 60

## Configuration Parameters · 61

Own Aircraft · 61

Installation · 62

Privacy · 63

Warnings · 64

Digital and Analog Inputs · 68

Audio Output · 70

Relay · 71

Flight Data Recorder · 72

WiFi Interface · 73

RS-232 data port 1 · 79

RS-232 data port 2 · 85

RS-232 data port 3 · 91

ARINC 429 Interface · 97

## Changelog · 99

AT-1 Software Version 23 · 99

AT-1 Software Version 22 · 100

AT-1 Software Version 21 · 101

AT-1 Software Version 18 · 102

AT-1 Software Version 16 · 103

AT-1 Software Version 15 · 104

AT-1 Software Version 12 · 105

---

AT-1 Software Version 11	· 106
AT-1 Software Version 10	· 107
AT-1 Software Version 9	· 108
AT-1 Software Version 8	· 109
AT-1 Software Version 7	· 110
AT-1 Software Version 6	· 111
AT-1 Software Version 5	· 112
AT-1 Software Version 4	· 114
AT1 Software Version 3	· 115
AT1 Software Version 2	· 117
AT1 Software Version 1	· 118
Environmental data	· 119



## 1.1 Introduction

This manual is intended to provide mechanical and electrical information for use in the planning and design of an installation of the Air Traffic (AT-1) into an aircraft. This manual is not a substitute for an approved airframe-specific maintenance manual, installation design drawing, or complete installation data package. Attempting to install equipment by reference to this manual alone and without planning or designing an installation specific to your aircraft may compromise your safety and is not recommended. The content of this manual assumes use by competent and qualified avionics engineering personnel and/or avionics installation specialists using standard aviation maintenance practices in accordance with relevant accepted practices. This manual is not intended for use by individuals who do not possess the competencies and abilities set forth above. Refer to section “Limitations” for additional information and other considerations.

## 1.2 Equipment Description

<i>Model</i>	<i>Part number</i>	<i>Description</i>
AIR Traffic	AT-1	Traffic Warning System based on FLARM and ADS-B Technology

AT-1 is a small, lightweight traffic/electronic conspicuity system based on FLARM and ADS-B technology. It detects the position of surrounding air traffic and transmits the own position to other aircraft that are equipped with compatible systems. It transfers traffic data and warning messages to compatible cockpit display systems, annunciators, and other avionics systems using various data interfaces.

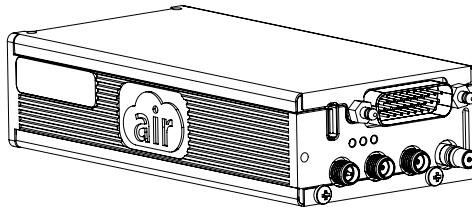

Figure 1.1.: AIR Traffic (AT-1) device.

## 1.3 System Capabilities

AT-1 detects other traffic transmitting FLARM, ADS-B or Mode-S transponder data. Moreover, AT-1 broadcasts the own aircraft's position, altitude, and trajectory to other aircraft using FLARM.

AT-1 exchanges data with avionics systems in the own aircraft using a broad range of standardized data interfaces. AT-1 is compatible to a wide range of cockpit systems including traffic displays, navigation systems, apps on tablets or smartphones, audio systems, and warning annunciators.

As there are neither minimum performance standards (MPS) nor technical standard orders (TSO) for FLARM based collision warning systems, AT-1 is not certified. It can be legally installed into many aircraft types based on several regulations covering installation of non-TSO articles, for example by means of EASA Standard Change Approvals (CS-STAN) or specific EASA Minor Change Approvals or Supplementary Type Certificates (STC) that have been created by AIR Avionics or third-party organisations.

AT-1 cannot be used as a replacement for certified TAS/TCAS systems. It may not be used as a substitute for these systems, especially, not in cases where the installation of TAS/TCAS systems is mandated.

## 1.4 Technical Specifications

### 1.4.1 Characteristics

<i>Parameter</i>	<i>Data</i>	<i>Unit</i>
<b>Mechanical</b>		
Dimensions	61.5 × 60.75 × 131.15	mm
Mounting	with mounting tray or attached to an AIR Traffic Display (ATD-57 or ATD-80)	
Mass	0.252	kg
<b>Electrical</b>		
Voltage (nom.)	13.8	V DC
Voltage (operational)	9 to 32	V DC
Low voltage shutdown	8	V DC
Current (nom.)	0.15	A

Please find a dimensional drawing in appendix B

### 1.4.2 Environmental Specifications

The environmental data for this device is only valid if the device is installed within an environment matching the qualification environment. The AT-1 has been tested in accordance with RTCA DO-160D.

A compliance statement can be found in appendix H.

### 1.4.3 Hardware

AT-1 has an all-metal housing. It features two power/signal connectors (D-SUB), four RF connectors, an optional static port connector, a USB port for data exchange, and an integrated WiFi antenna for wireless connectivity.

The device status is presented using three multi-color LEDs on the back of the unit.

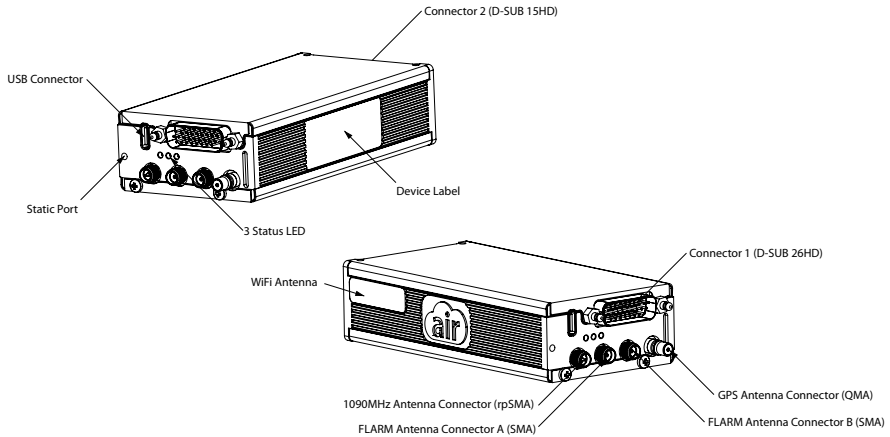

Figure 1.2.: Housing and connector overview

## 1.5 Regulatory Compliance

### 1.5.1 ETSO Functions

AT-1 does not cover any ETSO functions.

### 1.5.2 Deviations

Not applicable.

### 1.5.3 Non-ETSO Functions

AT-1 covers the following non ETSO functions:

- Sends and receives FLARM signals. Receives ADS-B signals and Mode-S transponder replies.
- Computes threat information for received traffic signals.
- Sends traffic data and warnings to other cockpit- and avionics systems.
- Puts out aural warnings and info messages.
- Delivers GPS data (SIL/SDA=0) to other cockpit- and avionics systems.

## 1.5.4 Telecommunication Standards and Conformity Declaration

Garrecht Avionik GmbH, as the device manufacturer declares that the apparatus AIR Traffic (AT-1) in all versions conforms with the essential requirements and other relevant provisions of the following directives and complies with the following standards:

### Traffic Transceiver

<i>Directive</i>	<i>Harmonized Standard applied</i>	<i>Equipment Properties</i>
R&TTE Directive 1995/5/EC	EN 300 220-1 V2.4.1 (2012-05)	Receiver Category 3, Transmitter duty-cycle 1%
R&TTE Directive 1995/5/EC	EN 300 220-2 V2.4.1 (2012-05)	
EMC Directive 2004/108/EC	EN 301 489-1 V1.9.2 (2011-09)	
EMC Directive 2004/108/EC	EN 301 489-3 V1.6.1 (2013-08)	Primary Function Type I Device Type 3

### WiFi Module

- Directives: 2014/35/EU, 2014/53/EU (RED), 1999/519/EC, 2011/65/EU
- Health and Safety: EN 62311:2008
- ERM: EN 301 489-1 V2.1.1, EN 301 489-17 V3.1.1, EN 300 328 V2.1.1
- EMC: EN 55022:2010/AC:2011

## 1.5.5 Limitations

AT-1 is subject to various limitations. Operational limitations can be reviewed in the AT-1 Pilot's Manual [2].

AT-1 does not replace ETSO certified Traffic Avoidance or Traffic and Collision Avoidance systems if required for a certain aircraft type or operation scenario.

## 1.5.6 Installation

It is the responsibility of those installing this article in a specific type or class of aircraft to determine that the aircraft installation conditions are within applicable standards. The article may be installed only if complying with applicable airworthiness requirements.

Please be aware that not all functions supported by AT-1 may be supported by connected display systems. Carefully observe the limitations and functions of connected devices in order to assess system limitations that apply to your aircraft. Please consult the section "Compatibility Considerations" on page 29 for details on supported connected display units.

## 1.6 Liability

IN NO EVENT WILL AIR AVIONICS BE LIABLE FOR ANY INCIDENTAL, SPECIAL, INDIRECT OR CONSEQUENTIAL DAMAGES, WHETHER RESULTING FROM THE USE, MISUSE OR INABILITY TO USE THE PRODUCT OR FROM DEFECTS IN THE PRODUCT.

## 1.7 Unpacking and Inspecting Equipment

Before installation into an aircraft, the equipment should be visually inspected for shipping damages and completeness. If the unit is damaged, notify the carrier. Do not return the unit to AIR Avionics before the carrier has authorized a claim.

The following parts are normally included with an AT-1:

<i>Part</i>	<i>Part number</i>	<i>Description</i>
1 x AT-1 main unit	AT-1	AT-1 main unit
1 x USB cable	B582	USB extension cable (1m)
1 x Data connector	FL15-26S7	D-SUB 26HD crimp connector, backshell, and, contacts
1 x FLARM Cockpit Antenna	B571	FLARM Antenna for cockpit installation (SMA)
1 x 1090 Cockpit Antenna	B572	ADS-B/XPDR Antenna for cockpit installation (rpSMA)
1 x GPS Antenna	B575	Active GPS Antenna for cockpit installation (QMA)

Should there be missing parts or spare parts required, please contact AIR Avionics or visit <http://www.air-store.eu>

## 1.8 Installation Materials

For obtaining installation material or tools, please visit <http://www.air-store.eu> or contact the AIR Avionics support.

### 1.8.1 Tools Required but not Supplied

Using crimp contacts for all connectors is recommended. The table below identifies crimp tools required to ensure consistent, reliable crimp contact connections for the D-Sub connectors.

<i>Military Part Number</i>	<i>Tool</i>
M22520/2-01	Hand crimping tool
M22520/2-06	Positioner (female)
M22520/2-09	Positioner (male)
M81969/14-01	Insertion and extraction tool

## 1.8.2 Parts Required but not Supplied

AT-1 is intended for use with standard aviation accessories. The following items are required for installation, but not supplied.

- Wire (MIL-W-22759/16 or equivalent)
- Shielded wire (MIL-C-27500 or equivalent)
- Push/Pull (manually resettable) circuit breakers
- Tie wraps or lacing cord

## 1.8.3 Optional Accessories

You can get optional accessories from <http://www.air-store.eu>.

<i>Part number</i>	<i>Description</i>
B569	D-SUB26HD connection kit with receptacle, backshell, crimp terminals, wire
B427	1m cable to AIR Traffic Displays (ATD-11/57/80) with power supply leads
B428	3m cable to AIR Traffic Displays (ATD-11/57/80) with power supply leads
B429	5m cable to AIR Traffic Displays (ATD-11/57/80) with power supply leads
B583	Static pressure port connector to connect to the aircraft static pressure port
B579	AT-1 mounting tray
B580	AT-1 D-SUB 26 HD connection kit for easy installation
B584	AT-1 installation kit for direct mounting of AT-1 on an AIR Traffic Display 57

AT-1 contains various connectors for power, data, and antennas.

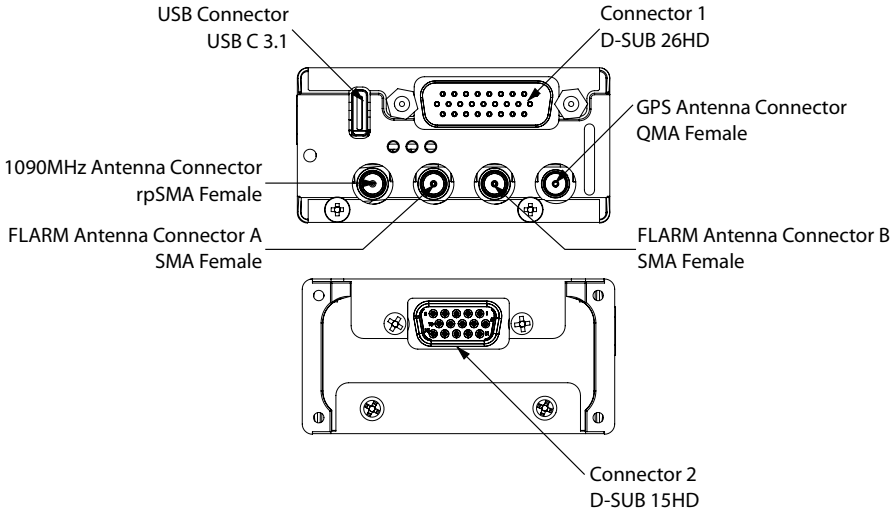

Figure 2.1.: System interconnects overview.

## 2.1 D-SUB Power/Data Connectors

Both data connectors are D-SUB high-density types. Connector one is a D-SUB26 HD male connector with 26 pins, connector two has 15 pins in a D-SUB15 HD female form factor. Small pin numbers are molded into the connectors for easier pin identification. Pin numbers of mating (male and female) connectors are identical, i.e. mating pins have identical numbers.

## 2.1.1 Connector 1

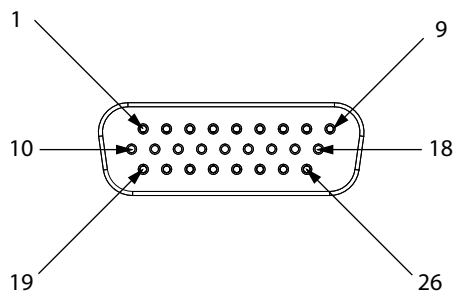

Figure 2.2.: Connector 1 pin map

<i>Pin Name</i>	<i>Pin number</i>	<i>I/O</i>
Aircraft Power (VIN)	1.1	In
RS-232 Port 1 receive data (RXD1)	1.2	In
RS-232 Port 2 receive data (RXD2)	1.3	In
RS-232 Port 3 receive data (RXD3)	1.4	In
Aircraft Ground (GND)	1.5	-
Analog Input (AIN)	1.6	In
Relay Output (ROUT)	1.7	Out
Relay Input (RIN)	1.8	In
Aircraft Ground (GND)	1.9	-
Aircraft Power (VIN)	1.10	In
RS-232 Port 1 transmit data (TXD1)	1.11	Out
RS-232 Port 2 transmit data (RXD2)	1.12	Out
RS-232 Port 3 transmit data (TXD3)	1.13	Out
Power Output 3.3V (3v3out)	1.14	Out
Audio Output (AUD)	1.15	Out
Discrete Input 1 ( $\overline{\text{DIN1}}$ )	1.16	In
Discrete Input 2 ( $\overline{\text{DIN2}}$ )	1.17	In
Discrete Input 3 ( $\overline{\text{DIN3}}$ )	1.18	In
Data Bus Low Signal (CANLO)	1.19	In/Out
Data Bus High Signal (CANHI)	1.20	In/Out
Data Bus Termination 120R (CANTERM)	1.21	-
Enable ( $\overline{\text{EN}}$ )	1.22	In
Aircraft Ground (GND)	1.23	-
ARINC429 Out A (A429A)	1.24	Out
ARINC429 Out B (A429B)	1.25	Out
Aircraft Ground (GND)	1.26	-

## 2.1.2 Connector 2

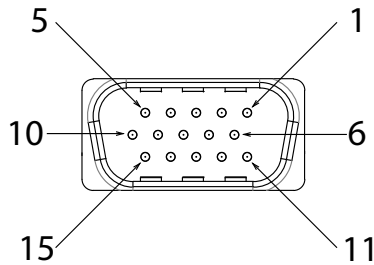

Figure 2.3.: Connector 2 pin map

<i>Pin Name</i>	<i>Pin number</i>	<i>I/O</i>
Aircraft Power Out (VOUT)	2.1	Out
RS-232 Port 2 transmit data (TXD2)	2.2	Out
RS-232 Port 2 receive data (RXD2)	2.3	In
Enable ( $\overline{EN}$ )	2.4	In
Aircraft Ground (GND)	2.5	-
Aircraft Power Out (VOUT)	2.6	Out
Data Bus Low Signal (CANLO)	2.7	In/Out
Data Bus High Signal (CANHI)	2.8	In/Out
Not Connected	2.9	-
Not Connected	2.10	-
Not Connected	2.11	-
Not Connected	2.12	-
Not Connected	2.13	-
Aircraft Ground (GND)	2.14	-
Not Connected	2.15	-

## 2.2 USB Connector

AT-1 features a USB 3.1 type C connector which serves as a USB host interface for USB thumb drives. A USB-C to USB-A jack (panel mount) extension cable is included with delivery. A standard USB thumb drive (USB-A) can be connected using this cable.

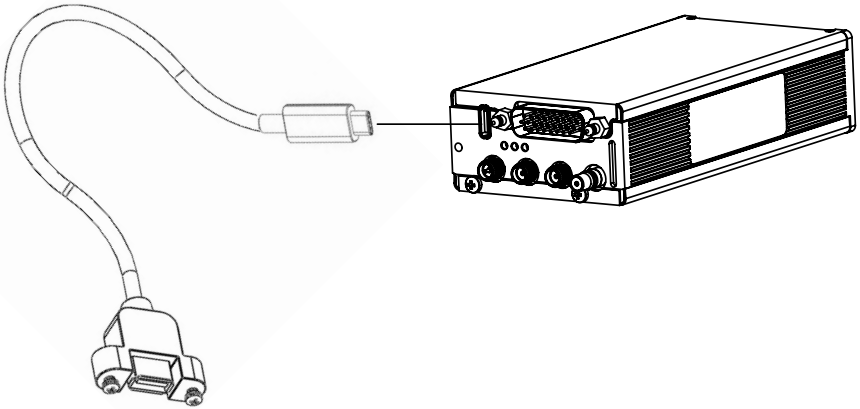

Figure 2.4.: USB connector and supplied extension cable

AT-1 does not supply enough power to charge personal devices via USB. Only connect USB thumb drives to the USB port. Connecting smartphones, tablets, or PCs may damage AT-1. If an overcurrent is detected, i.e. if a device draws more current from the USB port than specified, the USB power supply is switched off until AT-1 is restarted.

### 2.3 Antenna Connectors

AT-1 features four antenna connectors. The connectors have different polarity for FLARM, 1090 MHz, and GPS. Please make sure to always connect the connectors correctly. A wrong connection may damage the connector.

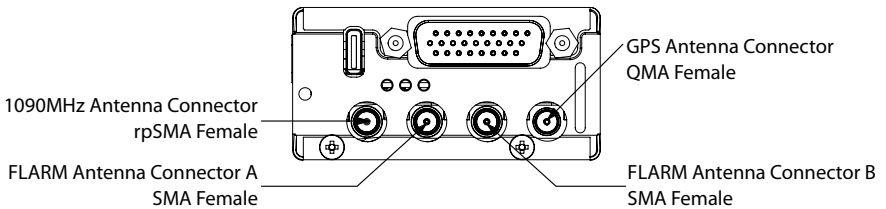

Figure 2.5.: Antenna connectors

Connector	Signal	Type
1090 MHz	ADS-B/transponder messages (receive)	rpSMA female
FLARM A	FLARM channel A (send/receive)	SMA female
FLARM B	FLARM channel B (send/receive)	SMA female
GPS	GPS (receive)	QMA female

## 2.4 Static Pressure Port

For some of its functions, AT-1 measures the barometric altitude. The unit features an integrated pressure sensor. For more precise readings, this pressure sensor can be connected to the aircraft's static pressure port using an optional static pressure port connector.

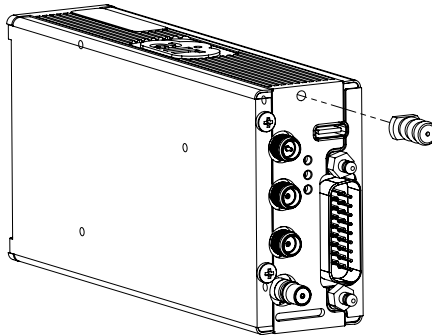

Figure 2.6.: The static port pressure connector can be optionally installed.

The static port adapter fits most aviation standard tubings and has an outer diameter of 6mm. The threading used to connect the adapter is M3 with a length of 3mm.

If the static port pressure connector is not installed, ensure that the static port of the unit is not covered.

# 3

## Interfaces

### 3.1 Serial Data Interface

AT-1 is capable of interfacing with other aviation instruments by sending and/or receiving serial data on its three serial data ports. All three serial data ports can be configured individually.

Pin Name	Pin number	I/O
RS-232 Port 1 data out (TXD1)	1.11	Out
RS-232 Port 1 data in (RXD1)	1.2	In
RS-232 Port 2 data out (TXD2)	1.12 / 2.2	Out
RS-232 Port 2 data in (RXD2)	1.3 / 2.3	In
RS-232 Port 3 data out (TXD3)	1.13	Out
RS-232 Port 3 data in (RXD3)	1.4	In

The serial inputs/outputs conform to RS-232C (EIA Standard) with a positive and a negative output voltage of at least 5V when driving a standard RS-232 load.

It is not sufficient that power supply ground on both devices is connected to aircraft ground. An additional direct ground connection is mandatory.

The use of a twisted pair shielded cable, e.g. MIL-C-27500-22TG 2T14 is highly recommended. With this cable both data wires and the GND reference can be connected using a single cable.

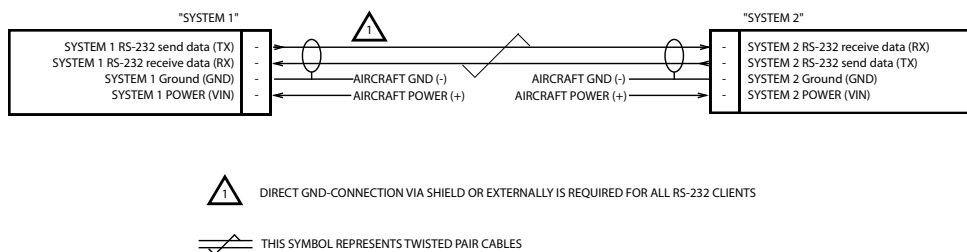

Figure 3.1.: Generic RS-232 wiring recommendation between "System 1" and "System 2"

The table below contains maximum recommended cable lengths when using shielded data cables for an RS-232 data interface. Exceeding these cable lengths may reduce signal integrity and compromise the reliability of the data interface.

<i>Data Rate</i>	<i>Max. Cable Length (meter)</i>	<i>Comment</i>
4800 Bd	30	Standard NMEA 0183 data rate, for GPS position data only
9600 Bd	15	Standard data rate for traffic data in the GARMIN TIS protocol
19,200 Bd	7.6	Standard data rate for traffic data in the FLARM protocol
38,400 Bd	3.7	–
57,600 Bd	2.6	–

## 3.2 ARINC429 Interface

AT-1 is capable of interfacing with other aviation instruments by sending an ARINC429 signal on its ARINC429 output.

AT-1 is compatible to a wide range of avionics systems using ARINC429 hardware interfaces. Please consult the section “Compatibility Considerations” on page 29 for details.

<i>Pin Name</i>	<i>Pin number</i>	<i>I/O</i>
ARINC429 Out A	1.24	Out
ARINC429 Out B	1.25	Out

The ARINC429 interface consists of two data wires. The differential high-speed signal requires twisted pair shielded cables, e.g. MIL-C-27500-22TG 2T14.

## 3.3 WiFi Interface

AT-1 features an integrated WiFi interface through which personal devices like tablets, smartphones, or computers can connect to AT-1.

AT-1 is compatible to a wide range of aviation apps for traffic display. Please consult the section “Compatibility Considerations” on page 29 for details.

## 3.4 Data Bus Interface

AT-1 uses a CAN data bus interface to connect to other AIR Avionics devices such as for example traffic display units.

Only AIR Avionics articles intended for use with AT-1 may be connected to the data bus.

<i>Pin Name</i>	<i>Pin number</i>	<i>I/O</i>
CAN Hi	1.20/2.8	In/Out
CAN Lo	1.19/2.7	In/Out
CANTERM	1.21	In/Out

Participating systems on a CAN data bus are frequently referred to as “nodes”.

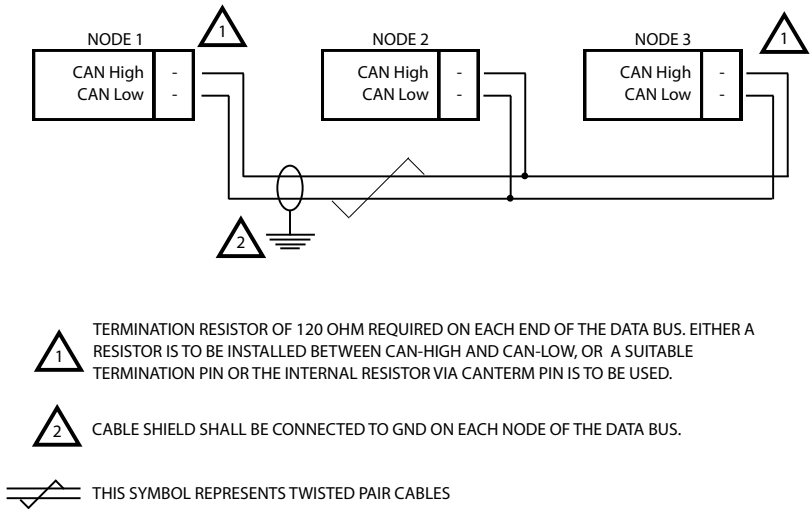

Figure 3.2.: Generic CANaerospace data bus wiring recommendation between bus nodes

The maximum recommended cable length between data bus nodes is 10m.

The data bus interface (CANaerospace) consists of two data wires. The differential high-speed signal requires impedance controlled shielded cables or at least twisted pair shielded cables.

The data bus interface requires termination resistors to be installed on each end of the bus (120 Ohm). On connector 2, a pin is available that is internally connected to the CAN Hi pin over a built-in 120 Ohm termination resistor. These pins can be used to terminate the data bus. External termination resistors are not required and shall not be installed if termination over these pins is used (recommended).

AT-1 sends and receives data using the CANaerospace<sup>1</sup> protocol. For a detailed description of supported datasets, please contact AIR Avionics support.

## 3.5 Power Supply and Enable Interface

### 3.5.1 Power Supply

The power inputs on connector 1 provide power. It is recommended to connect multiple power pins and multiple ground pins.

<sup>1</sup>To obtain the required specification, please contact “Stock Flight Systems” via <http://www.stockflightsystems.com>

<i>Pin Name</i>	<i>Pin number</i>	<i>I/O</i>
Aircraft Power	1.1/1.10	In
Aircraft Ground	1.5/1.9/1.23/1.26	-

We recommend the installation of a 3A manually resettable circuit breaker in the power supply line, e.g. a *Sensata Klaxon 7277-2-3*. Using such a circuit breaker ensures that the AT-1 can be switched off by the flight crew if required. Additionally, in the case of a non-permanent malfunction the power supply can be restored. The circuit breaker shall be clearly labeled.

Connection of the input power to incorrect pins can cause damage to the unit that will require return to the factory for repair. Ensure that the power supply is connected to the correct pins and does not short to any adjacent pins prior to applying power to the unit.

### 3.5.2 Power Output

Connector 2 features a supply power output. The output pins directly connect to the VIN pins on connector 1. Its main intention is to supply an AIR Traffic Display (ATD-11, ATD-57, or ATD-80) if the AT-1 is directly attached to such a display.

<i>Pin Name</i>	<i>Pin number</i>	<i>I/O</i>
Power Output	2.1/2.6	Out
Ground (GND)	2.5/2.14	-

### 3.5.3 Enable Interface

Both connectors feature a pin that enables power when pulled to ground/low. For AT-1 to power up, at least one of these two pins must be connected to ground (GND). Active-Low discrete inputs like the Enable Interface are considered active if either the voltage to ground is below a certain minimum or if the resistance to ground is below approximately 300 Ohms.

<i>Pin Name</i>	<i>Pin number</i>	<i>I/O</i>
Enable	1.22/2.4	In (Active Low)

If the AT-1 is installed in combination with an AIR Traffic Display (ATD-11, ATD-57, or ATD-80), the pin is automatically pulled to ground/low when the ATD is powered up.

An external switch can be connected if AT-1 is to be switched on/off manually.

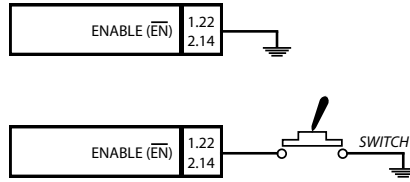

Figure 3.3.: If the AT-1 is not installed in combination with an AIR Traffic Display, or another device compatible to the enable-interface, either Pin 1.22 or pin 2.4 have to be connected to GND. Connection can be made permanently (the AT-1 is always switched on if supply power is present) or over a switch (AT-1 is only switched on if the connection to GND is made)

### 3.6 Audio Output

The AT-1 audio output on pin 1.15 provides an audio signal to an audio panel, an intercom, or an external speaker.

The audio signal can either be configured as a voice output (traffic warnings, status messages) or a beep tone (sine wave).

The audio output volume level is adjustable by means of a configuration parameter (permanently configured to a certain level) or an analog voltage present at pin 1.6 (can be changed in-flight), e.g. by using a rotary potentiometer that is installed into the instrument panel.

In some installations, for example if connecting the AT-1 to an avionics audio panel (input impedance typically 500Ohm), it may be required to install an impedance matching transformer 1:4 or similar.

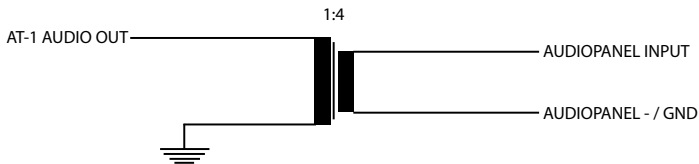

Figure 3.4.: Wiring diagram of a 1:4 transformer.

Various configuration parameters are available. For details, please consult the configuration parameter list in appendix F.

## 3.7 Discrete Inputs

AT-1 features a range of discrete inputs. Active-Low discrete inputs are considered active if either the voltage to ground is below a certain minimum or if the resistance to ground is below approximately 300 Ohms.

These inputs can optionally be used together with switches or pushbuttons in the airframe or instrument panel to trigger specific functions once the switch source is exercised:

<i>Function Name</i>	<i>Description</i>	<i>Switch type</i>
MUTE	The AT-1 audio output can be muted.	Toggle switch
NO ALARMS	Traffic warnings issued over the AT-1 data interfaces can be suppressed.	Toggle switch
ON GND	In this case, the switch sets the aircraft's state as on-the-ground.	Airframe switch (WOW)
APPROACH MODE	In approach mode, the warning sensitivity is reduced. This mode can be used during IFR approaches or while flying in close formations.	Toggle switch
VOICE ACK	Acknowledges a voice message for 5 minutes, e.g. a traffic warning from a specific traffic target.	Pushbutton

We recommend installing the on-ground function only in combination with an airframe switch (weight-on-wheel).

All switches must be clearly labeled for easy identification by the flight crew.

# 4

## Installation Overview

### 4.1 General Handling Recommendations

#### 4.1.1 ESD Handling Recommendations

To avoid damage to the AT-1, take precautions to prevent Electrostatic Discharge (ESD) when handling the unit, connectors, and associated wiring. ESD damage can be prevented by touching an object that is of the same electrical potential as the unit before handling the unit itself.

### 4.2 Workmanship

Installation of avionics equipment into an aircraft is a complex task that requires expert skills and know-how. While some installation practices may lead to quicker results, only practices that provide for excellent durability and reliability are acceptable. As many avionics systems have a life cycle of several decades, a durable and reliable installation in compliance to strict workmanship standards is of utmost importance.

#### 4.2.1 Workmanship

“Workmanship is defined as the control of design features, materials and assembly processes to achieve the desired durability and reliability for subassembly interconnections, specifically those in printed wiring assemblies and cable harnesses, and the use of inspection techniques and criteria to assure interconnect quality. Workmanship promotes standardized designs and fabrication practices to enhance assembly durability and reliability and restricts the use of designs and manufacturing processes known to reduce those qualities.”<sup>1</sup>

#### 4.2.2 Standards

Always follow acceptable avionics installation practices. Installation must always follow regulatory requirements.

Many military or civil standards for avionics installations are acceptable.

#### NASA Workmanship Standards

As an addition to regulatory requirements we recommend installation in accordance to NASA WORKMANSHIP STANDARDS. These standards provide for an excellent overview and in-detail knowledge on acceptable practices including explanations and a pictorial

---

<sup>1</sup>Source: <http://nepp.nasa.gov/workmanship>

reference. NASA WORKMANSHIP STANDARDS are publicly available on this website: <http://nepp.nasa.gov/workmanship>

### Pictorial Reference

On <http://workmanship.nasa.gov> a pictorial reference “intended to provide insight to certified operators, inspectors and instructors who visually assess the compliance of flight hardware to locally applicable requirements”<sup>2</sup> is available.

## 4.3 Cabling and Wiring Considerations

### 4.3.1 General Wiring Considerations

Wiring should be installed in accordance with applicable regulations.

- It should not be possible for a cable harness to be exposed to wire chafing.
- Route the wiring bundle as appropriate. Avoid sharp bends.
- Secure all wires in order to minimize vibration damage.
- Preferably shielded wire is to be used.
- Use 22 AWG wire for all connections unless otherwise specified.
- The cable harness should not be located near flight control cables and controls, high voltage lines or fuel lines.
- The cable harness should be located in a protected area of the aircraft.
- Do not route cable near high voltage sources.

For the D-SUB connectors, crimp terminals and mating receptacles are recommended because these are more reliable than soldered connections, and are easier to assemble in-situ in an aircraft, where soldering is impractical. They also allow individual wires to be removed and replaced in a receptacle without replacing the whole connector.

For power supply, manually resettable circuit breakers are strongly recommended. These circuit breakers allow for individual devices to be switched off without compromising other systems on the same power bus.

### 4.3.2 Special Wiring Requirements for ARINC429 and Data Bus

- Shielded wire must be used for differential ARINC429 and data bus signals as specified in the interconnect drawing.
- Termination resistors are required on each end of a CAN data bus installation. ARINC429 does not require termination resistors.

If wiring requirements are not met, equipment performance may be compromised.

<sup>2</sup>Source <http://workmanship.nasa.gov>

## 4.4 Antenna Considerations

Good antenna placement and installation is important. FLARM signals are transmitted with very low power. Therefore, a good antenna installation is critical for equipment performance. Also the 1090 MHz and GPS antennas do have to be installed following certain requirements. If antennas are not installed in an optimum position, range and coverage are limited.

Cockpit antennas for installation inside the cockpit are included with delivery of AT-1 (dipole antennas). Cockpit antennas are fairly easy to install and in some aircraft types provide decent results. Yet, depending on the signal type, external antennas are recommended.

### 4.4.1 Antenna cable installation

- Route the antenna cable as appropriate, avoid sharp bends.
- Secure all cables in order to minimize vibration.
- The antenna cable should not be located near flight control cables and controls.
- The antenna cables must never be squeezed or chafed.

### 4.4.2 FLARM Antennas

In Europe, FLARM signals are transmitted with an output power of roughly between 10 and 25mW. This is about 10,000 times weaker than a typical transponder signal or 200 times weaker than a VHF radio. Therefore, especially the FLARM antenna installation is crucial. Please ensure that all of the below-mentioned requirements are met as closely as possible.

#### FLARM Cockpit Antennas

The FLARM cockpit antenna included with delivery is a dipole antenna that has an adhesive pad in the center.

1. Always install FLARM antennas vertically.
2. Ensure that the antenna cable is routed away from the antenna in an orthogonal way in the first 15 cm (6 inches) or use angled antenna connectors.
3. Do not coil the antenna cable. Make sure it is as short as possible. Only experts with professional tools may shorten the FLARM antenna cable.
4. Ensure that no conductive parts (metal, carbon fiber) are close to the antenna.
5. Install the antenna in a location where it has a clear view and is not obstructed by structural parts.
6. If using multiple FLARM antennas, please make sure that they are located far away from each other to increase coverage. The reception range is not increased by multiple antennas, only the reception coverage is increased. Therefore, it makes little sense installing two FLARM antennas closely to each other, because then they cover the same area. Ensure that both antennas cover different areas for good results, e.g. on the top and on the bottom of the aircraft fuselage.

One cockpit antenna comes included with delivery. Using a second FLARM antenna may provide better results as the reception coverage would be increased.

The following locations have proven to be good places for installation of cockpit antennas. Other places may be suitable as well.

- Attached to the front windshield or the side windows. This only works for windows or windshields that allow vertical installation of the antenna. For example, in Cessna/Piper aircraft, a good place would be on the side of the front windshield with adequate distance to metal structures.
- Inside fiberglass nose cones of most twin engine aircraft or gliders.
- Inside fiberglass structures like wingtips.

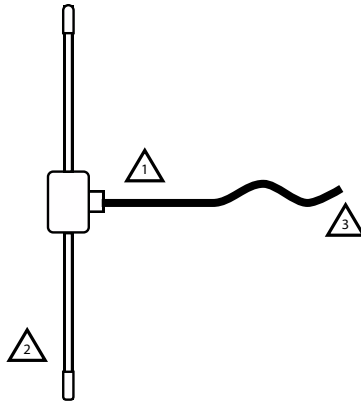

- △ 1 Ensure that the antenna cable is routed away from the antenna in an orthogonal way.
- △ 2 Always install dipole antennas vertically
- △ 3 Do not coil the antenna cable.

Figure 4.1.: Cockpit antenna and required orientation.

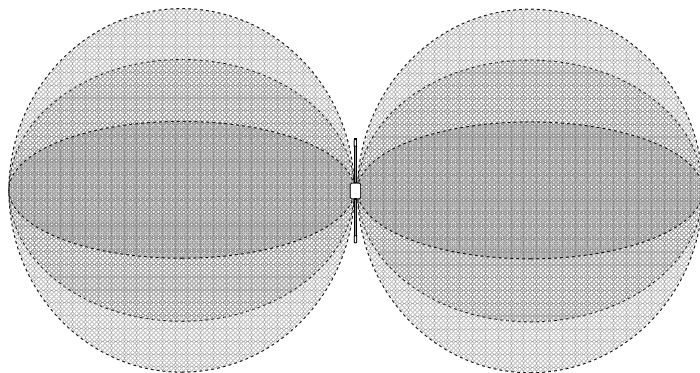

Figure 4.2.: Cockpit antenna reception/radiation pattern

### FLARM External Antennas

In aircraft that are mostly made of conductive materials such as metal or carbon fiber, we recommend the installation of at least one external antenna for FLARM. Normally, such an external antenna would be placed underneath the fuselage of the aircraft.

In larger metal aircraft, coverage can be significantly increased by using two external antennas on the top and on the bottom of the fuselage.

1. Always install FLARM antennas vertically on a conductive surface of at least a 15 cm (6 inches).
2. Ensure that the antenna cable is routed away from the antenna in an orthogonal way in the first 15 cm (6 inches) or use angled antenna connectors.
3. Do not coil the antenna cable. Make sure it is as short as possible. Only experts with professional tools may shorten the FLARM antenna cable.
4. Ensure that no conductive parts (metal, carbon fiber) are close to the antenna on the outside.
5. Install the antenna in a location where it has a clear view and is not obstructed by structural parts like the landing gear.
6. If using multiple FLARM antennas, please make sure that they are located far away from each other to increase coverage. The reception range is not increased by multiple antennas, only the reception coverage is increased. Therefore, it makes little sense installing two FLARM antennas closely to each other, because then they cover the same area. Ensure that both antennas cover different areas for good results, e.g. on the top and on the bottom of the aircraft fuselage.
7. Try to avoid placing the antenna closer than 1m from the aircraft's transponder, DME, and TAS antennas. Try to avoid placing the antenna closer than 30 cm from the aircraft's VHF antennas.

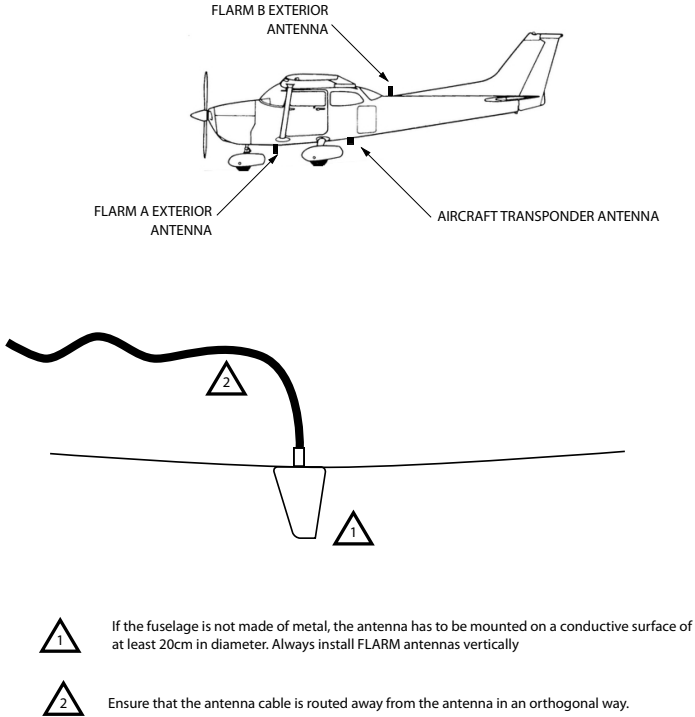

Figure 4.3.: External antenna (dual FLARM antenna setup)

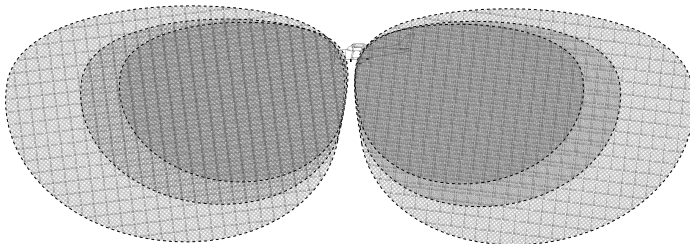

Figure 4.4.: External antenna reception/radiation pattern

#### 4.4.3 1090 MHz Antennas

Transponder and ADS-B signals are sent with a high output power. Therefore, even in suboptimal antenna installations good reception ranges can be achieved.

### 1090 MHz Cockpit Antennas

In most cases, the cockpit antennas included with delivery are sufficient for good operation. Although not being as critical as FLARM antennas, make sure the requirements below are met for optimum performance.

1. Always install 1090 MHz antennas vertically.
2. Ensure that the antenna cable is routed away from the antenna in an orthogonal way in the first 15 cm (6 inches) or use angled antenna connectors (for external antennas).
3. Do not coil the antenna cable.
4. Ensure that no conductive parts (metal, carbon fiber) are close to the antenna.
5. Install the antenna in a location where it has a clear view and is not obstructed from nearby structural parts.

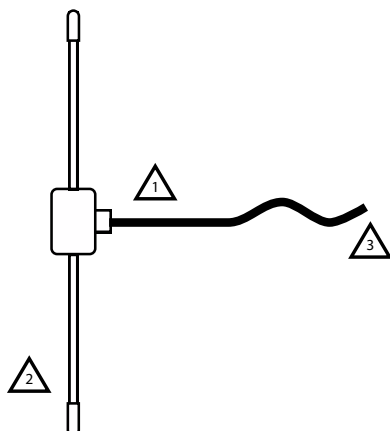



-  Ensure that the antenna cable is routed away from the antenna in an orthogonal way.
-  Always install dipole antennas vertically
-  Do not coil the antenna cable.

Figure 4.5.: Cockpit antenna and required orientation.

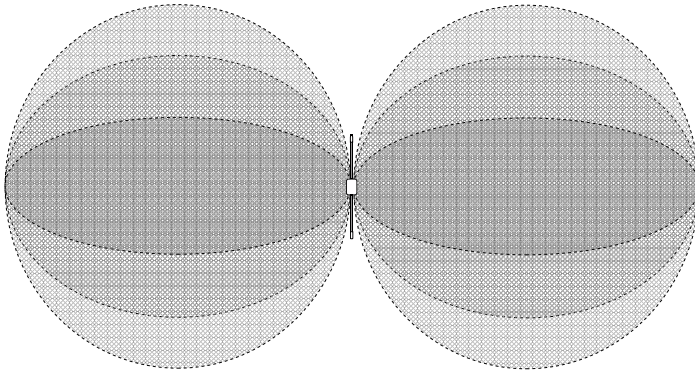
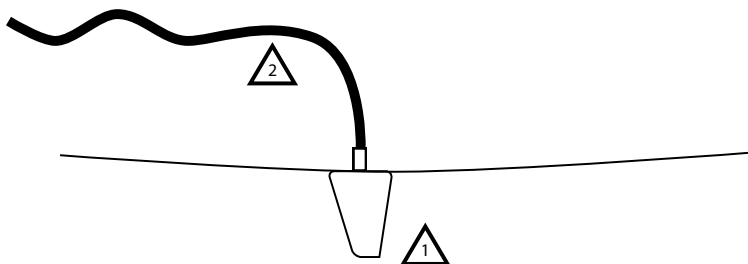

Figure 4.6.: Cockpit antenna reception/radiation pattern

### 1090 MHz External Antennas

In larger aircraft that are mostly made of conductive materials such as metal or carbon fiber, installing an external antenna for 1090 MHz may be beneficial for optimum performance. Normally, such an external antenna would be placed underneath the fuselage of the aircraft.

1. Always install 1090 MHz antennas vertically on a conductive surface of at least a 15 cm (6 inches) diameter.
2. Ensure that the antenna cable is routed away from the antenna in an orthogonal way in the first 15 cm (6 inches) or use angled antenna connectors (for external antennas).
3. Do not coil the antenna cable.
4. Ensure that no conductive parts (metal, carbon fiber) are close to the antenna.
5. Install the antenna in a location where it has a clear view and is not obstructed from nearby structural parts like the landing gear.
6. Try to avoid placing the antenna closer than 1m from the aircraft's transponder, DME, and TAS antennas.



If the fuselage is not made of metal, the antenna has to be mounted on a conductive surface of at least 20cm in diameter. Always install 1090MHz antennas vertically



Ensure that the antenna cable is routed away from the antenna in an orthogonal way.

Figure 4.7.: External 1090 MHz antenna

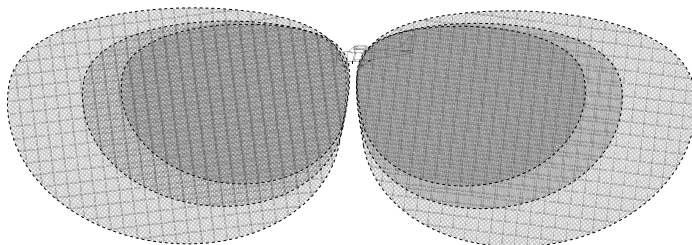

Figure 4.8.: External antenna reception/radiation pattern

#### 4.4.4 GPS Antennas

AT-1 comes with a cockpit GPS antenna with an adhesive pad. It can be installed on the instrument panel glare shield or any other place with unobstructed view of the sky. Good GPS performance is important for correct operation. Please make sure that the requirements below are met as closely as possible.

In larger aircraft that are mostly made of conductive materials such as metal or carbon fiber, or for aircraft with heated windshields, installing an external GPS antenna may be required for optimum performance. Normally, such an external antenna would be placed on top of the fuselage of the aircraft.

1. Always install the GPS antenna lying flat horizontally and facing upwards.

2. Do not coil the antenna cable.
3. Do not paint or cover the antenna.
4. Ensure that no conductive parts (metal, carbon fiber) are located above of the antenna. Conductive, grounded parts below of the antenna may improve GPS antenna performance.
5. Install the antenna in a location where it has a clear view of the sky and the largest unobstructed possible opening angle.
6. Do not install the antenna closer than 30 cm (1 ft) away from another active GPS antenna.



Figure 4.9.: GPS antenna reception angle

## 4.5 Pressure Tubing Considerations

Pressure tubing should be installed in accordance with applicable regulations.

- Route the tubing as appropriate. Avoid sharp bends.
- Make sure the aircraft static pressure port is plumbed directly to the unit static pressure input port.
- Secure all tubes in order to minimize vibration.
- Ensure that no deformations of the airframe surface have been made that would affect the relationship between static air pressure and true ambient static air pressure for any flight condition.
- The pressure tubing should not be located near flight control cables and controls.
- AT-1 should not be at the low point of the static plumbing lines in order to avoid moisture or debris collecting at or near the unit.
- Use care to avoid getting fluids or particles into the pneumatic port.

## 4.6 AT-1 Mounting Considerations

AT-1 is designed to be mounted in the avionics compartment or behind the instrument panel of an aircraft. Depending on the aircraft's individual requirements other locations may be suitable as well.

Not all compatible cockpit systems are capable of displaying status messages from AT-1. Some cockpit systems do not show any other messages than traffic data and therefore the system state is not shown to the flight crew. If there is no system in your installation that is capable of displaying status messages, please install AT-1 in a position where the status LEDs can be monitored by the flight crew.

**Be sure that no aircraft controls and emergency features interfere with AT-1.**

Two mounting options are possible:

- AT-1 can be mounted remotely in a mounting tray or mounting rack.
- AT-1 can be directly attached to an *AIR Avionics* AIR Traffic Display (ATD-57 or ATD-80).

When mounting the AT-1 directly on an ATD-57 or ATD-80, please ensure that the quick-lock bolts in the ATD are removed and the supplied replacement screws are installed prior to mounting the AT-1. Removing the Quick-lock bolts without installing the new screws will damage the ATD internally.

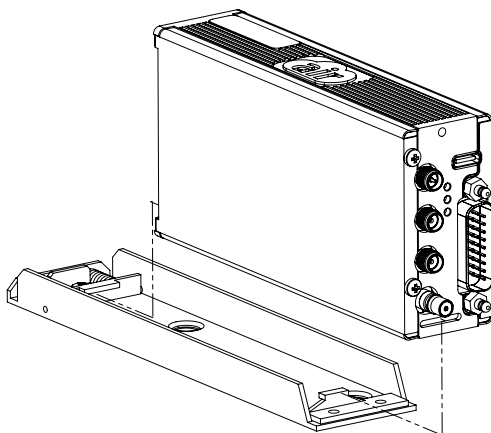

Figure 4.10.: AT-1 mounted in a tray.

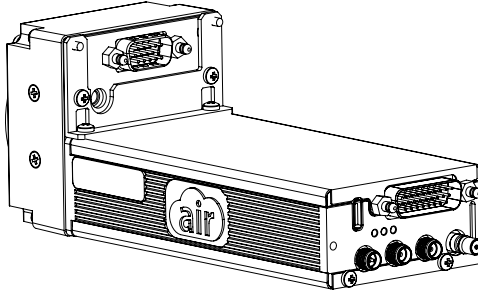

Figure 4.11.: AT-1 mounted directly on an ATD-57.

## 4.7 Compatibility Considerations

As AT-1 does not feature a display or a speaker. Other systems must be used to make received traffic data and threat information available to the flight crew. AT-1 is designed to be connected to a broad range of different systems that display and process traffic data. Care must be taken to ensure that all connected devices are compatible with the AT-1.

The following list gives an overview of the most common compatible systems. In general, several hundred systems are compatible. If AT-1 is to be connected with other than the below mentioned tested devices, compatibility must be assessed on a per installation level.

Not all functions supported by AT-1 are supported by all compatible devices. For example, not all configuration parameters can be set inside the menus of such devices.

### 4.7.1 Compatible Cockpit Displays of Traffic Information

The following cockpit displays of traffic information have been tested to be compatible with AT-1.

<i>Device</i>	<i>P/N</i>	<i>Make</i>	<i>Interface</i>	<i>3D Traffic Display</i>	<i>Non BRG Traffic</i>	<i>Setup.</i>
AIR Traffic Display	ATD-XX	AIR Avionics	RS232 NMEA	●	●	●
Butterfly Display 57	B102	AIR Avionics	RS232 NMEA	●	●	–
Butterfly Display	B101	AIR Avionics	RS232 NMEA	●	●	–
FLARMView 57		LXNav	RS232 NMEA	●	●	–
FLARMView		LXNav	RS232 NMEA	●	●	–
FLARMLD		LXNav	RS232 NMEA	Limited	Limited	–
Traffic Monitor		LXNavigation	RS232 NMEA	●	●	–
V2		Ediatec	RS232 NMEA	Limited	–	–
V3 / V3+ / V4		Aboba	RS232 NMEA	Limited	Limited	–

## 4.7.2 Compatible Navigation Systems

### Panel-Mount EFIS/Navigation Systems

The following panel-mount systems are compatible with the AT-1.

<i>Device</i>	<i>Status</i>	<i>Make</i>	<i>Interface</i>	<i>3D Traffic Display</i>	<i>Non BRG Traffic</i>	<i>Setup</i>
GNS430/520/W	Tested. Ver. 6.03	GARMIN	ARINC429	●	●	–
GTN650/750	Tested. Ver. 6.42	GARMIN	ARINC429	●	●	–
G500/G1000	Not tested but assumed compatible	GARMIN	ARINC429	●	●	–
IFD440/540	Not tested but assumed compatible	Avidyne	ARINC429	●	●	–
Evolution	Not tested but assumed compatible	Aspen	ARINC429	●	●	–
G3X / G3X touch	Tested	GARMIN	RS232 TIS	●	Limited	–
Skyview	Tested	Dynon	RS232 TIS	●	Limited	–

None of the above mentioned systems is capable of displaying FLARM obstacle or FLARM alert zone warnings.

### Portable Navigation Systems

The following portable navigation systems have been tested to be compatible to AT-1.

<i>Device</i>	<i>Make</i>	<i>Interface</i>	<i>3D Traffic Display</i>	<i>Non BRG Traffic</i>	<i>Setup.</i>
495/496	GARMIN	RS232 TIS	●	Limited	–
695/696	GARMIN	RS232 TIS	●	Limited	–
AERA 500/550	GARMIN	RS232 TIS	●	Limited	–
AERA 600	GARMIN	RS232 TIS	●	Limited	–
AERA 795	GARMIN	RS232 TIS	●	Limited	–

None of the above mentioned systems is capable of displaying FLARM obstacle or FLARM alert zone warnings.

## Navigation Apps

The following navigation apps have been tested to be compatible to AT-1.

<i>App</i>	<i>Make</i>	<i>Interface/ Protocol</i>	<i>3D Traffic Display</i>	<i>Non BRG Traffic</i>	<i>Setup. and updates</i>
iGlide/iPilot	AIR Avionics	WiFi/NMEA	●	●	–
Skydemon	Skydemon	WiFi/NMEA	●	●	–
AirNav Pro	XAMPLE	WiFi/NMEA	●	●	–
Runways HD	AIRBOX	WiFi/NMEA	●	●	–
SkyMap	SkyMap	WiFi/NMEA	●	●	–
FlyMap	Stauff	WiFi/NMEA	●	●	–
EasyVFR	PocketFMS	WiFi/NMEA	●	●	–
FOREFLIGHT	Foreflight	WiFi/GDL90	●	●	–
Enroute Flight Navigation	Akaflieg Freiburg	WiFi/NMEA	●	●	–

## 4.8 Air Circulation and Cooling

AT-1 does not require external cooling. However, lower operating temperatures extend equipment life. Reducing the operating temperature extends the mean time between failures (MTBF).

Units tightly installed heat each other through radiation, convection, and sometimes by direct conduction. Even a single unit operates at a much higher temperature in still air than in moving air. Fans or some other means of moving the air around electronic equipment are usually a worthwhile investment.

## 4.9 Compass Safe Distance

After reconfiguring the avionics in the cockpit panel, if AT-1 is mounted less than 30 cm from the compass, recalibrate the compass and make the necessary changes for noting correction data.

# 5

## Installation Procedures

We recommend installing AT-1 following these steps:

1. Equipment mounting.
2. Manufacturing and testing of wiring harness or selection of standard accessories.
3. Wiring harness and interconnect installation.
4. Antenna installation.
5. Post installation configuration, checkout, and documentation.

### 5.1 Equipment Mounting

#### 5.1.1 Using a Mounting Tray

1. Prepare the mounting holes for the AT-1 mounting tray.
2. Install the mounting tray in your aircraft. Ensure there is sufficient space for the AT-1 main unit and all of the required cables and connectors.
3. Install the device in the mounting tray. Make sure the integrated locking lever has locked correctly.

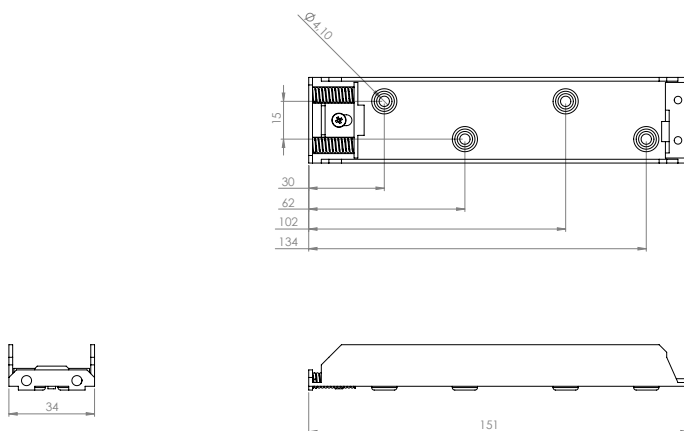

Figure 5.1.: Mounting tray dimensions

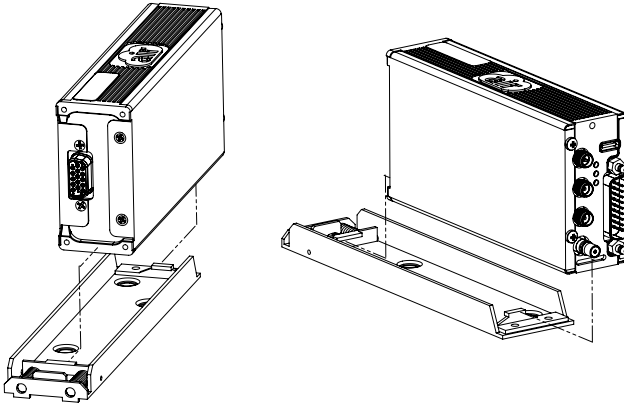

Figure 5.2.: AT-1 installation in the tray.

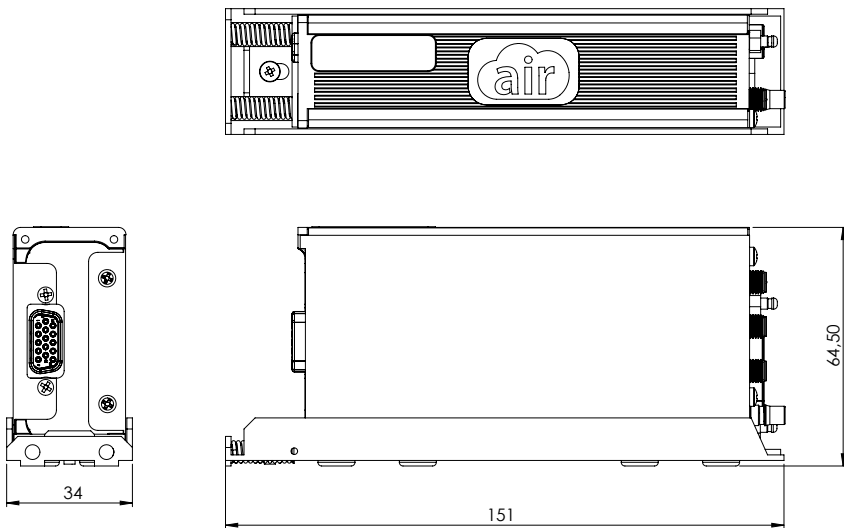

Figure 5.3.: AT-1 mounted in a tray with dimensions.

If the connector 2 is used to connect a cable (optional), be careful with the fixing screws that are screwed into the connector 2 of the AT-1. Mounting a cable without the screws will damage the AT-1 internally. Never remove the screws without replacing them with suitable screws, e.g. D-SUB bolts, before connecting a cable, otherwise, the AT-1 will be damaged. Such damage is not covered by the warranty.

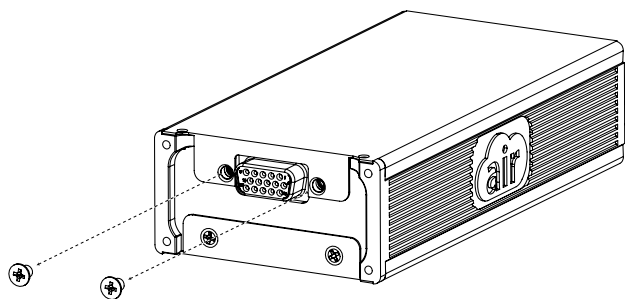

Figure 5.4.: Screws on connector 2. Never remove these screws without proper replacement!

### 5.1.2 Using an AIR Traffic Display (ATD-57 or ATD-80)

In order to install the AT-1 on an AIR Traffic Display 57 (ATD-57), a mounting kit with bracket and small parts is required (B584). For mounting on an ATD-80, a different kit (B623) is used.

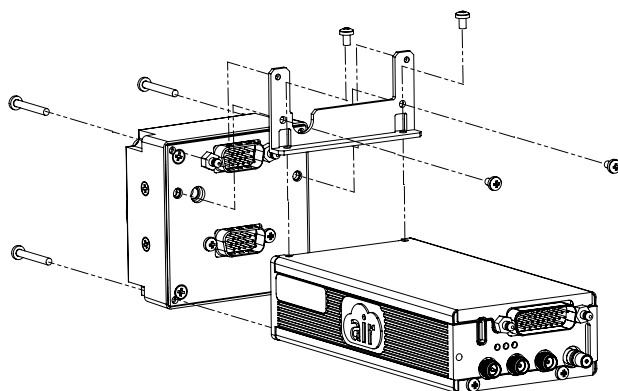

Figure 5.5.: Exploded drawing of ATD-57, AT-1, and all small parts of the optional mounting kit.

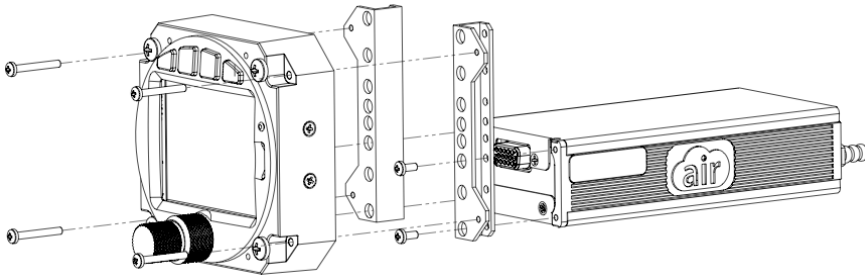

Figure 5.6.: Exploded drawing of ATD-57, AT-1, and all small parts of the optional mounting kit.

1. Prior to installation of the combination of ATD and AT-1, if already installed, please uninstall the ATD.
2. On the ATD, remove the quicklock D-Sub pins and install the supplied screws into the ATD.
3. Install the AT-1 mounting bracket on the ATD. Connect connector 2 of AT-1 to the lower rear connector (connector 2) of ATD.
4. Use the supplied screws to secure AT-1 on the ATD, install the ATD/AT-1 combination in the instrument panel using the supplied M3 panel screws.

After removing the quicklock pins from the ATD, please insert the supplied UNC screws. Mounting an AT-1 without the screws will damage the ATD internally. Never remove the fixing screws that are screwed into the connector 2 of the AT-1 without replacing them with suitable screws, e.g. D-SUB bolts. Even if your device is mounted on a display, these screws must always remain screwed in, otherwise the device will be damaged. Such damage is not covered by the warranty.

## 5.2 Wiring

Wiring depends on many factors such as selected installation options, connected devices, and aircraft specific requirements.

In most cases, an individual wiring harness is manufactured. We recommend using MIL SPEC aviation wire, crimp contacts, and "Quicklock" D-Sub backshells. Wiring diagrams for most common installation cases are given in appendix D.

In some cases standard accessories may be used. Appendix C shows a list of example installations using standard accessories as well as recommended configuration parameters for these installations.

## 5.3 Antenna Installation

For antenna mounting location considerations, please refer to aircraft manufacturer data and/or other applicable documentation. Best practices for antenna placement and cable routing are described in section 4.4.

1. Install all antennas in their positions.
2. Organise and secure all antenna cables.

## 5.4 Interconnect Installation

1. Install all electrical connectors and ensure that they are appropriately secured.
2. Install the antenna connectors and ensure that they are secured.
3. Optionally, install the static pressure connector and ensure that the tubing connection is leak-proof.

## 5.5 Post Installation Configuration, Checkout, and Documentation

A summary of the steps required for checkout, configuration, and installation documentation is as follows:

- Perform the installation checks. Instructions can be found in chapter 6.
- Configure the unit for the specific installation. Work through every configuration item of the instructions in chapter 7.
- Perform ground checks. Instructions can be found in chapter 8.
- Update the aircraft documentation. Instructions can be found in chapter 10.

This chapter contains instructions for checking out an AT-1 installation. Checks shall ensure that the system is properly installed and functions correctly.

## 6.1 Wiring Checks

Verify that all cables are properly secured. Check the movement of aircraft controls to verify that there is no interference between the cabling and the controls. Ensure that all wiring is installed as described.

Prior to powering up AT-1, the wiring harness must be checked for proper connections. Point to point continuity must be checked to expose any faults such as shorting to ground or wrong connections.

After accomplishing a continuity check, perform power and ground checks to verify that proper power and GND levels are present. Any faults or discrepancies must be corrected at this time.

Any faults or discrepancies must be corrected before proceeding.

## 6.2 Connector Engagement Checks

Prior to powering up the AT-1, a connector engagement check should be performed.

1. Optically inspect all interconnects.
2. Check if all data connectors are locked properly, verify by gently pulling on the connectors.
3. Ensure that the antenna connectors are installed and tightened correctly.
4. Ensure that the pressure tubing sits tightly and completely covers the pressure connector.

AT-1 may be connected to power after completion of the continuity and power checks. All connections must be made before the unit is powered up.

In order to work properly, AT-1 must be configured for the installation environment. For example, the own aircraft's identification shall be entered in order to avoid nuisance traffic warnings resulting from reception of signals transmitted by the own aircraft.

AT-1 can be configured in several ways:

1. Using the AT-1 configuration webpage by connecting a web browser on a PC, smartphone, or tablet.
2. Using a connected compatible traffic display like the AIR Traffic Display (ATD-11, ATD-57, or ATD-80) that allows for AT-1 configuration.
3. Using a configuration file loaded into the AT-1 by means of a USB thumb drive.

We exclusively recommend configuration through the AT-1 configuration webpage. Therefore, this manual only covers the parameter structure available on the AT-1 configuration webpage. It is possible to configure all available parameters of AT-1 on the configuration webpage.

## 7.1 AT-1 Configuration Webpage

### 7.1.1 Accessing the AT-1 Configuration Webpage

The AT-1 configuration webpage is accessible via any WiFi capable device such as a PC, a smartphone, or a tablet (referred to as a "personal device" here). Please follow these steps to access the configuration webpage:

#### Joining the AT-1 WiFi Network

1. Open the WiFi configuration page in your personal device. Normally you can find this page in the settings/system preferences app of your personal device.
2. Select the AIR Traffic WiFi network and establish a connection. The network name/SSID will be "AIR-Traffic-" followed by the last two digits of the serial number of the AT-1.
3. Enter the network password. The password is the full serial number as printed below the bar code on the sticker on the device, for example *AT1-00003*.

If establishing a connection is not possible, please ensure the WiFi interface in AT-1 has been activated during installation. Depending on its setup, the WiFi interface might only work for 15 minutes after power-on. In this case, please open the AT-1 configuration webpage directly after switching the device on and change the setup for the WiFi interface to be permanently active.

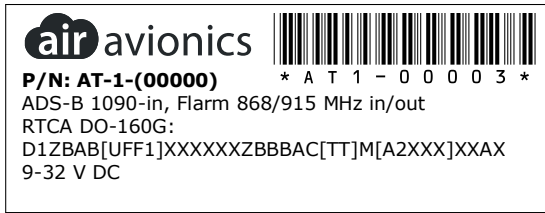

Figure 7.1.: AT-1 serial number sticker

## Opening the AT-1 Configuration Webpage

1. Open a web browser in your personal device.
2. Enter the following address into the address bar of the browser and hit enter:  
*http://192.168.1.1*

## 7.2 Simple, Advanced, and Expert Configuration Mode

As the AT-1 factory defaults already cover most of the requirements for normal installations, only few changes have to be made. Therefore, a simple configuration mode is available that covers the basic configuration parameters required for normal installations.

We strongly recommend to only use the simple configuration mode, unless you are a very experienced installer and know exactly what you are doing. Setup parameters in the advanced and expert configuration modes will negatively affect device performance if not set correctly.

In the advanced configuration mode, more parameters are configurable. In the expert configuration mode, all parameters are configurable without limitations. To enter the expert configuration mode, a pin code entry is required. In the advanced configuration mode, on the AT-1 configuration webpage, please enter the pin code and click on **Switch To Expert Configuration** to open the expert configuration.

Pin Code: 3000

### 7.2.1 Parameter Mapping

Parameters in the simple configuration are mapped to parameters in the advanced and expert configuration and vice versa. Therefore, it is possible to toggle between all configuration modes seamlessly at any time.

Some simple configuration mode parameters affect multiple advanced/expert configuration mode parameters. In such cases, if switching back to the simple configuration mode, a direct mapping is not possible and the value "expert config" is shown in the affected simple configuration field.

## 7.2.2 Change Highlighting

All parameters that have been changed during the current configuration session (while the AT-1 is running), are highlighted in *magenta* color.

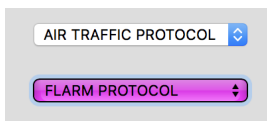

Figure 7.2.: Parameters on the AT-1 configuration webpage. The upper parameter has not been changed, the lower one has been changed and is shown in magenta.

## 7.2.3 Saving or Discarding Changes

Two buttons are located below the configuration parameters that allow to save or discard configuration changes. To save the configuration changes made, click on Save. To discard all changes, click on Cancel.

## 7.3 Simple Configuration

### 7.3.1 Own ICAO Address (HEX)

To identify signals from the own transponder, AT-1 uses the aircraft's unique ICAO 24 bit address, also called "HEX Code".

Entering this code is mandatory for AT-1 to function properly.

If your aircraft does not have an ICAO address (e.g. because you do not have a Mode-S transponder or 406MHz ELT installed and no ID has been assigned to your aircraft yet), please enter "FFFFFF" instead.

### 7.3.2 Own Aircraft Category

Configure the category of aircraft the AT-1 is installed in. This parameter adjusts warning thresholds to suit the operational requirements of the aircraft category.

### 7.3.3 WiFi Interface Activation

Gives options to activate the integrated WiFi interface. If not using an in-flight WiFi data connection, we recommend setting this option to "First 15 Minutes On". This allows WiFi functions like the AT-1 configuration webpage to be accessed within the first 15 minutes after power-on. After 15 minutes, the WiFi interface is switched off for saving power.

Be careful! Setting this option to "Always Off" will render the AT-1 configuration webpage via WiFi inaccessible.

### 7.3.4 WiFi Interface Output

Selects the data output for the WiFi Interface. We recommend using the FLARM protocol or the GDL90 protocol, depending on your app's requirements.

### 7.3.5 RS-232 Data Port 1 Output

Selects the data output for the RS-232 data port 1.

This data port is normally used to provide other avionics systems like Mode-S transponders, emergency locator transmitters (ELT), or the AIR Control Display with NMEA 0183 GPS data.

Therefore, by default this data port transmits NMEA 0183 GPS data at 4,800 Bd.

### 7.3.6 RS-232 Data Port 2 Output

Selects the data output for the RS-232 data port 2.

This data port is normally used to provide other avionics systems, for example, traffic displays with traffic data.

Therefore, by default this data port transmits traffic data in the FLARM protocol at 19,200 Bd.

Please note that this port is also available on connector 2. Therefore, this port is used when connecting a traffic display on connector 2, for example an AIR Traffic Display.

### 7.3.7 RS-232 Data Port 3 Output

Selects the data output for the RS-232 data port 3.

This data port is normally used to provide other avionics systems like EFIS or handheld navigators with traffic data.

Therefore, by default this data port transmits traffic data in the GARMIN TIS protocol at 9,600 Bd.

## 7.4 Expert Configuration

Please find a list of all available configuration parameters in appendix F.

## 8.1 Simulator for Ground Checks

In order to ground-check AT-1 efficiently, a comprehensive simulator function has been implemented. The simulator is capable of simulating:

- Several valid or invalid GPS positions, pressure altitude and ground speed of the own aircraft.
- Several types of traffic targets with different threat levels.
- Traffic warnings from “normal” and non-bearing targets.
- FLARM alert zone and obstacle warnings.

### 8.1.1 Activating the Simulator

To activate the simulator, please open the AT-1 configuration webpage as described in section 7.1.1 and navigate to the simulator controls by clicking on [Show Simulator Control](#). After the AT-1 is switched off, the simulator is automatically deactivated.

## 8.2 Interface Checkout

### 8.2.1 Serial Interface Check

The serial data interface of the unit can be checked with a pragmatic function test.

1. Connect AT-1 and another compatible avionics system via a serial data port.
2. Verify correct operation.

We recommend the use of professional RS-232 analysis tools to check data bus integrity.

### 8.2.2 ARINC429 Interface Check

The ARINC429 data interface of the unit can be checked with a pragmatic function test.

1. Connect AT-1 and another compatible avionics system via ARINC429.
2. Verify correct operation of the interface in the compatible avionics system’s debug console.

Please note: Without movement of the own aircraft, the AT-1 is unable to determine the own aircraft’s current heading. Without a current heading, no traffic data is transmitted over the ARINC429 interface and the status "STANDBY" is shown. While

sitting on the ground, if the simulator is not active, no traffic data is shown. Please use the simulator function for testing.

We recommend the use of professional ARINC429 analysis tools to check the data interface integrity.

### 8.2.3 Data Bus Checks

In order to test data bus integrity and bus load, a pragmatic function test of AT-1 connected to a second bus node can be performed. After at least 20 minutes of continuous operation, check data validity and correct function by checking and verifying that no errors have been detected.

We recommend the use of professional CANaerospace analysis tools to check data bus integrity.

### 8.2.4 WiFi Check

In order to check if the integrated WiFi interface is working, please connect a WiFi capable device to the AT-1 and check if the data transfer works.

If you want to use the simulator mode in combination with an aviation app for testing, please proceed as follows:

1. Start the simulator mode on the AT-1 configuration webpage.
2. The data connection to your aviation app does not work while the AT-1 configuration webpage is open. Close the AT-1 configuration webpage in your web browser.
3. Open your app and test as desired. The simulator will only be active as long as the AT-1 is running. After the AT-1 has been power cycled, the simulator mode will be deactivated.

## 8.3 Discrete Inputs Check

1. For each of the switches that are connected, exercise the switch source.
2. Verify that the function controlled by the switch operates as intended.
3. If the switch is exercised and does not cause the AT-1 to operate as intended, verify the wiring between the AT-1 and the switch.

## 8.4 Audio Check

Be careful. Depending on the impedance of your audio system, the test sounds may be extremely loud. Never test with a headset on your head before having verified that the volume level is appropriate.

1. AT-1 plays a test sound every time it is switched on. The test sound is either a test beep or the phrase "AIR TRAFFIC" (if the voice output is activated).

2. Verify that the test sound is played correctly.
3. If a potentiometer is used for volume control, verify its correct operation by changing the level with the potentiometer. Every time the volume level is changed using the potentiometer, a volume indication test beep is played.

## 8.5 Version / Revision Check

Verify that the currently installed software version/revision is approved and suitable for your device, aircraft, and configuration. Especially check if the FLARM software version is current. You can review version information on AT-1 configuration webpage via WiFi.

## 8.6 Traffic reception tests

Verify that the AT-1 is receiving traffic while on the ground. A pragmatic test using a connected traffic display is recommended. All kinds of traffic targets, these are FLARM, ADS-B and bearingless transponder targets should be shown depending on the traffic situation.

## 8.7 Failure Message Check

Check for failure messages. Verify that no functions have failed and that no failure messages are visible. If you are unable to open the AT-1 configuration webpage via WiFi and if there is no system in your installation that is capable of displaying error messages, please monitor the status LEDs instead.

AT-1 features comprehensive self-test and diagnosis functions. These functions help the installer and the user to identify issues and to check the system status.

In addition to transmitting failure and status messages over its data ports to connected aviation instruments, AT-1 features three multi-color status LED and shows its status on the AT-1 configuration webpage via WiFi.

For details on failures and abnormal operation, please consult the AT-1 Pilot's Manual [2].

For a comprehensive list of possible failure modes and corresponding error messages, please consult the AIR Avionics Error Message index [1]

## 9.1 Status LED

### 9.1.1 LED Positions

The device status of the AT-1 is shown using three multi-color LEDs located in the back of the AT-1 unit.

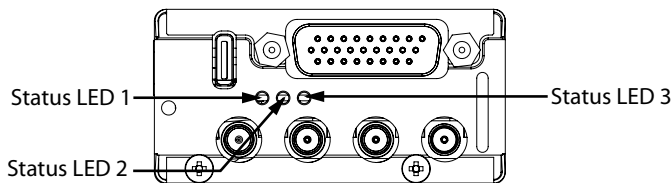

Figure 9.1.: Three status LEDs on the back of the AT-1 main unit

### 9.1.2 Status LED Assignment

Each status LED is assigned to specific functional modules inside the AT-1:

1. Status LED 1 shows the status of the integrated 1090 MHz receiver module.
2. Status LED 2 shows the status of the integrated FLARM transceiver module.
3. Status LED 3 shows the status of the integrated GPS receiver module, the integrated WiFi module and the general system state.

### 9.1.3 Lighting Patterns











#### Normal Operation: Status LED 1

<i>Status</i>	<i>LED 1 Pattern</i>	<i>LED 1 Color</i>
Fatal error/failure, 1090 MHz receiver module unavailable.		red
Last dataset from 1090 MHz receiver module has been received over 30 seconds ago.		red
Last dataset from 1090 MHz receiver module has been received over 3 seconds ago.		red
Reduced function error of 1090 MHz module		yellow
Normal operation, ADS-B/Transponder traffic has been received or is currently received		green
Never received a traffic signal via 1090 MHz (ADS-B/Transponder)		green





























#### Normal Operation: Status LED 2

<i>Status</i>	<i>LED 2 Pattern</i>	<i>LED 2 Color</i>
Fatal error/failure, FLARM transceiver module unavailable.		red
FLARM software incompatible or expired.		red
Last dataset from FLARM transceiver module has been received over 30 seconds ago.		red
Last dataset from FLARM transceiver module has been received over 3 seconds ago.		red
Reduced function error of FLARM module		yellow
No GPS datasets received from FLARM module.		yellow
No FLARM data (about the own ship) sent out by FLARM transceiver module.		yellow
Power supply problem in the FLARM transceiver module.		yellow
Normal operation, FLARM traffic has been received and is sent.		green
Never received a traffic signal via FLARM		green

















## Normal Operation: Status LED 3

<i>Status</i>	<i>LED 3 Pattern</i>	<i>LED 3 Color</i>
Fatal error/failure, AT-1 main system unavailable.		red
Fatal error of GPS or WiFi, for example, GPS antenna not connected		red
Last GPS position has been received over 30 seconds ago or never.		red
Last GPS position has been received over 3 seconds ago.		red
Reduced function error affecting traffic data processing and warnings. For example, no barometric pressure data is available.		yellow
Reduced function error not directly affecting traffic data processing/warnings. For example, the USB interface has detected a current consumption above maximum rating.		yellow
Warning: Bad GPS reception		yellow
Normal function, GPS 3D fix, no errors		green
GPS 2D fix		green
GPS has invalid fix quality, no error		green
GPS acquiring satellite data, no errors		green

## Status LED Patterns for Maintenance Operation

<i>Status</i>	<i>LED 1</i>	<i>LED 2</i>	<i>LED 3</i>
Searching for USB thumb drive after power-on	blue 	blue 	blue 
Reading configuration from USB thumb drive	blue 	blue 	off
Reading config. from USB successfully finished	blue 	blue 	green 
Reading config. from USB failed: no or invalid file	blue 	blue 	yellow 
Reading config. from USB failed: file syntax	blue 	blue 	red 
Writing log file to USB USB thumb drive	blue 	off	blue 
Writing log file to USB successfully finished	blue 	green 	blue 
Writing log file to USB failed	blue 	red 	blue 
Initiating maintenance of the 1090 MHz module	blue 	off	off
Initiating maintenance of the FLARM module	off	blue 	off
Updating the FLARM module	off	blue 	off
Loading FLARM license or obstacle file	off	blue 	off
Initiating maintenance of the WiFi module	off	off	blue 
Updating WiFi module	off	off	blue 
Updating WiFi module, 2nd attempt after update error	off	off	blue 

## Bootloader/Update Operation

<i>Situation</i>	<i>LED 1</i>	<i>LED 2</i>	<i>LED 3</i>
Initializing bootloader	magenta 	off	off
Bootloader initialized successfully	off	magenta 	off
Flash checked: no application installed	magenta 	off	magenta 
Flash checked: application installed ok	off	off	magenta 
Flash checked: incompatible application	magenta 	magenta 	magenta 
Bootloader processing a software container file	magenta 	magenta 	magenta 
Bootloader is installing application	magenta 	magenta 	magenta 
Bootloader has finished the installation ok	magenta 	magenta 	magenta 

## 9.2 AT-1 Status Information on Configuration Webpage

Comprehensive status information is shown in the “Device Info” section on the AT-1 configuration webpage. To open the configuration webpage, follow the steps described in section 7.1.1.

Hide Device Info

### Info

<b>Device Serial:</b> Device serial number	1000000	<b>HW Version:</b> Hardware revision	AT-1-(0000)
<b>SW Version:</b> Software version	10014	<b>BL Version:</b> Bootloader version	3
<b>Flarm Obst DB:</b> FLARM obstacle database status and name.	0	<b>Flarm Obst DB Expire:</b> FLARM obstacle database expiration date.	UNKNOWN
<b>Flarm RadioID:</b> FLARM radio ID	0_209C56	<b>Flarm Region:</b> FLARM region	WORLD
<b>Flarm SW Expire:</b> FLARM software expiration date.	2019-02-01	<b>Flarm SW Version:</b> FLARM software version	6.40
<b>Flarm Capabilities:</b> FLARM capabilities.	DP2_RFB	<b>TRX SW Version:</b> TRX software version	0.38
<b>WiFi SW Version:</b> WiFi software version	83		

### State

<b>System Time [s]:</b> Time since last power-on in seconds. All timestamps in system info or error messages are based on this time.	4693.9	<b>GPS State:</b> Current state of the integrated GPS receiver module.	NO FIX
<b>TRX State:</b> Current state of the integrated 1090MHz (ADS-B/Transponder) receiver module.	0 TRAFFIC DATASETS RECEIVED	<b>Flarm State:</b> Current state of the integrated FLARM transceiver module. The current GPS position is required for full FLARM functionality. The FLARM system will not transmit or receive FLARM data without a valid GPS fix.	NO TRANSMISSION

### Errors

Time	Code	Severity	Description
4692.4	64	Function Reduced	AT-1: GPSANTENNA OPEN

Figure 9.2.: Screenshot of the “Device Info” section in the AT-1 configuration web page

## 10.1 Configuration Documentation

It is mandatory for each configuration that the configuration is logged in a document that is added to the aircraft records.

The AT-1 configuration webpage features a print button for easier configuration logging. Open the configuration webpage as described in section 7.1.1, then use the [Print this Page](#) button to print a copy of the entire system configuration.

## 10.2 Checkout Documentation

It is mandatory for each installation that the checkout is logged in a document that is added to the aircraft records.

A checkout log form is provided in appendix E

## 11.1 Software Packages and Expiry

Please be aware that the FLARM software component expires if not updated regularly.

When the FLARM software expires, the FLARM functions can no longer be used. Always ensure to use the most current version!

We recommend updating the AT-1 software on a yearly basis, for example during the aircraft's annual inspection.

AIR Avionics offers software package files including all software for the various submodules that are integrated in an AT-1. Software for the FLARM transceiver module, the 1090 MHz receiver module, the WiFi module, and the core module is included in a single file.

## 11.2 Software/Database Loading

Software updates and the obstacle database are loaded using a USB thumb drive (USB stick). A USB jack capable of hosting a thumb drive is shipped with AT-1 and normally installed into the aircraft.

Never remove the USB thumb drive while the device is booting. The device's software may stop working. In this case a system restart would be required.

Inserting the USB thumb drive in the wrong orientation may damage the slot.

AT-1 is compatible to all FAT or FAT32 formatted USB thumb drives normally in use with Windows PC or Apple Macintosh computers. It has been successfully tested with USB thumb drives with a storage capacity of 2 to 64 gigabytes.

### 11.2.1 Loading Software to the AT-1

To install a new software version, please carry out the following steps:

1. Download the latest AT-1 update file from <https://www.air-avionics.com>.
2. Load the update file onto a USB thumb drive into the root folder (main folder, no subfolder).
3. Insert the USB thumb drive into the AT-1 or the USB jack of the installed USB extension cable while AT-1 is powered off.
4. Power the AT-1 on. The update is automatically loaded. Please wait at least 15 minutes before removing the USB thumb drive.

## 11.2.2 Loading an Obstacle Database

To install an obstacle database, please carry out the following steps:

1. Purchase a valid obstacle database file from <https://www.flarm.com>.
2. Load the obstacle database file onto a USB thumb drive into the root folder (main folder, no subfolder). Please ensure that the file name is no longer than 8 characters. If too long, please shorten the file name.
3. Insert the USB thumb drive into the AT-1 or the jack of the installed USB extension cable while AT-1 is powered off.
4. Power the AT-1 on. The database is automatically loaded. Please wait at least 10 minutes before removing the USB thumb drive.

When the database license expires, the database can no longer be used and database functions are no longer available.

# A

## Bibliography

- [1] AIR Avionics, *AAVECI-EN – AIR Avionics Error Code Index*, October 2018.
- [2] AIR Avionics, *AT-1: Pilot's Manual EN*, August 2018.

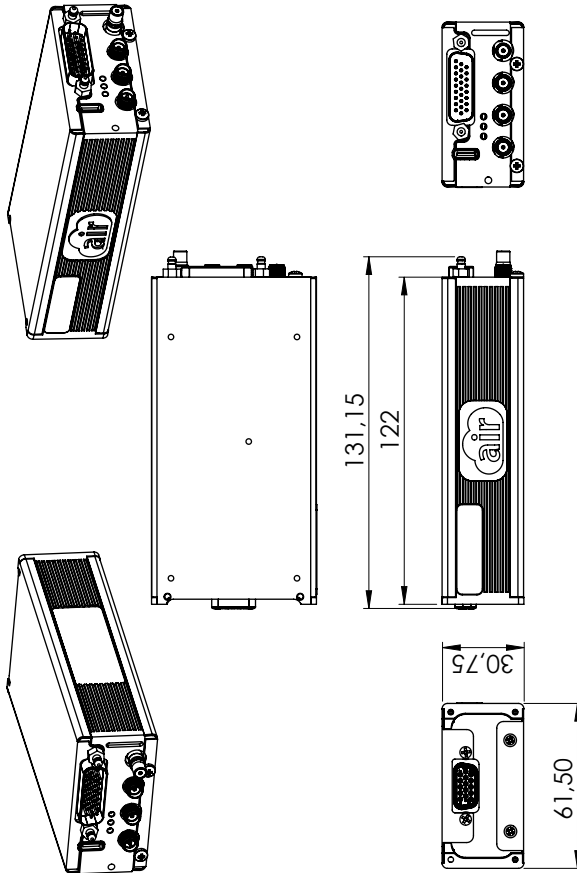

Figure B.1.: Dimensional drawing, all dimensions in millimeters

## Cabling and Configuration Examples

### C.1 GARMIN GTN 650 and 750

For connection to a GARMIN GTN, the ARINC429 data interface is used. Any of the four ARINC429 inputs of the GTN750 and any of the two ARINC 429 data inputs of the GTN650 can be used.

In the GTN ARINC429 setup, please configure the interface speed to *HIGH* and the data protocol to *TRAFFIC 1*.

The following traffic status messages will appear in the GTN:

<i>AT-1 System Status</i>	<i>GTN Status Indication</i>
Switched off	TAS FAIL, NO DATA
Switched on, no GPS signal yet	STANDBY
Switched on, GPS working	OPERATE
Switched on, traffic received	OPERATE

Please note that GTN does not support obstacle and alert zone warnings.

Please note that the GTN is only capable of displaying traffic on the map if it is connected to a heading source. Depending on requirements, AT-1 can be used as a heading source. Please see the expert configuration mode parameter list in appendix F for details.

The GTN pin map can be found in the GTN Installation manual.

### C.2 GARMIN GNS 430/530 (WAAS and non-WAAS versions)

For connection to a GARMIN GNS, the ARINC429 data interface is used. Any of the two ARINC429 inputs can be used.

In the GNS ARINC429 setup, please configure the interface speed to *HIGH* and the data protocol to *TRAFFIC ADVISORY*.

The following traffic status messages will appear in the GTN:

<i>AT-1 System Status</i>	<i>GTN Status Indication</i>
Switched off	TAS FAIL, NO DATA
Switched on, no GPS signal yet	STANDBY
Switched on, GPS working	OPERATE
Switched on, traffic received	OPERATE

Please note that GNS does not support obstacle and alert zone warnings.

Please note that the GNS is only capable of displaying traffic on the map if it is connected to a heading source. Depending on requirements, AT-1 can be used as a heading source. Please see the expert configuration mode parameter list in appendix F for details.

The GTN pin map can be found in the GTN Installation manual.

# D

## Wiring Diagrams

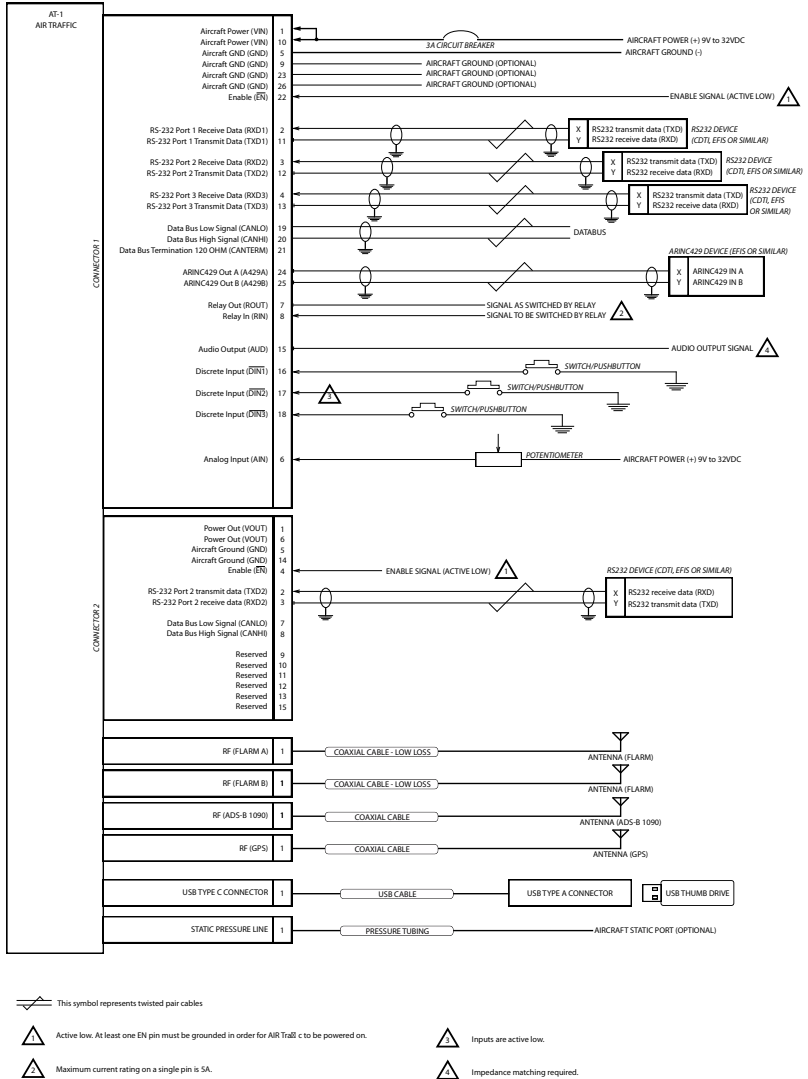

Figure D.1.: Generic wiring diagram

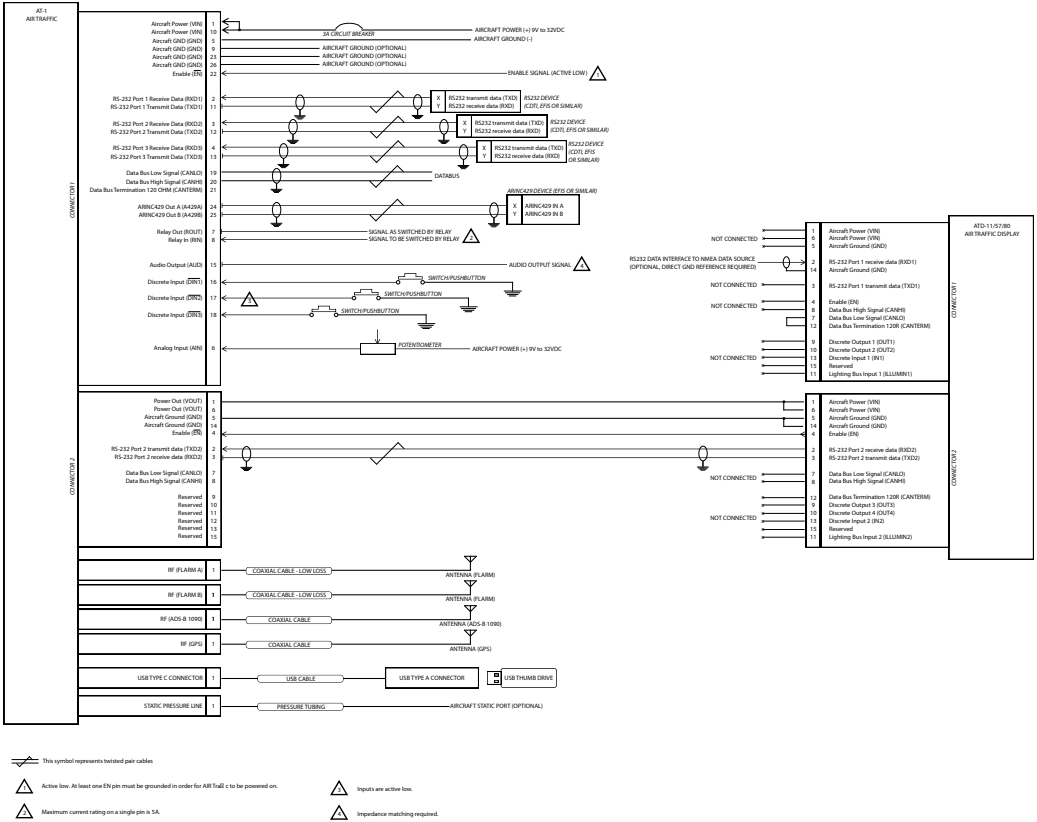

Figure D.2.: Wiring diagram with an AIR Traffic Display

## E.1 Installation

1.  The installation has been performed in accordance with the instructions shown in this manual.
2.  Wiring checks have been performed.
3.  Connector engagement checks have been performed.

## E.2 Ground Checks

1.  Serial interface checks have been performed. /  Check not required.
2.  ARINC429 interface check has been performed. /  Check not required.
3.  Data Bus check has been performed. /  Check not required.
4.  WiFi check has been performed. /  Check not required.
5.  Discrete input check has been performed. /  Check not required.
6.  Audio check has been performed. /  Check not required.
7.  Version check has been performed.
8.  Traffic reception check has been performed.
9.  Failure message check has been performed.

## E.3 Interference Checks

1.  EMI test and check for interference has been performed.

## E.4 Documentation

1.  Aircraft documentation updated.
2.  All documentation, including this log and the configuration log has been filled out/printed and stored in a safe place together with other aircraft documents.

I hereby confirm the above mentioned steps have been completed and that no issues, problems or failures have been found.

Name, date, signature \_\_\_\_\_

## F.1 Own Aircraft

### F.1.1 Own ICAO Address (HEX)

#### Description

To identify signals from the own transponder, AT-1 uses the aircraft's unique ICAO 24 bit address, also called 'HEX Code'. Entering this code is mandatory for AT-1 to function properly. If your aircraft does not have an ICAO address, for example, because you do not have a Mode-S Transponder or 406MHz ELT installed and, therefore, no ID has been assigned to your aircraft yet, please enter 'FFFFFF' instead.

- **Item Code:** ACFTADDR
- **Valid Values:** 6-digit hex number
- **Default Value:** FFFFFFF

### F.1.2 Own Aircraft Category

#### Description

Configure the category of aircraft the AT-1 is installed in. This parameter adjusts warning thresholds to suit the operational requirements of the aircraft category.

- **Item Code:** FLARMACFT
- **Valid Values:** integer value, 0 - 15
- **Default Value:** 8

## F.2 Installation

### F.2.1 Use Own Mode-S Altitude Signal

#### Description

Activating this option disables the integrated pressure sensor and uses the pressure altitude encoded into the own aircraft's transponder replies. Only recommended in pressurized aircraft and if the static port of the AT-1 cannot be used.

- **Item Code:** MODESALT
- **Valid Values:** ON, OFF
- **Default Value:** OFF

### F.2.2 GPS Track Fallback

#### Description

Selects the fallback value for the own GPS-track-derived heading if no GPS-based ground track is available. This is the case if the ground speed is too low for a stable track estimation. However, the fallback value is used only if valid GPS data is available.

- **Item Code:** GPSTRKFALLBACK
- **Valid Values:** NONE, TRUENORTH
- **Default Value:** NONE

### F.2.3 1090MHz Receiver Attenuation

#### Description

Tunes the field strength based distance estimation of non-bearing transponder signals. This value is set in [dB], a positive value reduces target distance vs receiver field strength, a negative value increases the distance.

- **Item Code:** TRXCABLELOSS
- **Valid Values:** integer value, -12 - 12
- **Default Value:** 0

### F.2.4 GPS Antenna Supply Voltage

#### Description

Sets the bias voltage used to supply active GPS antennas with power. Be very careful, antennas may be permanently damaged if the voltage is not set correctly.

- **Item Code:** GPSANTSUPPLY
- **Valid Values:** OFF, 3, 5
- **Default Value:** 3

## F.3 Privacy

### F.3.1 No-Track Mode

#### Description

Enables the FLARM no-track option. If enabled, the own ship will not be tracked by ground-based receivers, e.g. by FlightRadar24 or OpenGliderNet.

- **Item Code:** FLARMNOTRACK
- **Valid Values:** ON, OFF
- **Default Value:** OFF

### F.3.2 Stealth Mode

#### Description

Enables the FLARM Stealth Mode. If enabled, your own aircraft's FLARM data will be obscured from other FLARM users. Only traffic warnings will be given at an appropriate time. We do not recommend enabling this mode.

- **Item Code:** FLARMSTEALTH
- **Valid Values:** ON, OFF
- **Default Value:** OFF

## F.4 Warnings

### F.4.1 Warnings On-Ground

#### Description

Enable warnings while the aircraft sits on the ground or moves slower than the On-Ground Threshold Speed. If this parameter is disabled, warnings are suppressed on ground.

- **Item Code:** WARNONGND
- **Valid Values:** ON, OFF
- **Default Value:** OFF

### F.4.2 On-Ground Threshold Speed [m/s]

#### Description

Speed threshold (ground speed) for On-Ground detection. If warnings on ground are disabled, this settings affects the output of alarms. Be very careful with this value!

- **Item Code:** ONGNDTHR
- **Valid Values:** integer value, 0 - 1000000
- **Default Value:** 10

### F.4.3 Protection Volume 1 Range [m]

#### Description

Adjusts the horizontal size of the 'protection volume 1'. Inside this volume, independent from flight vectors, a certain threat level is set for any traffic target. Protection Volume 1 has the highest priority. It overrules all other protection volumes. Be very careful! Do not change this value unless you know exactly what you are doing. Adjusting this parameter wrongly may suppress traffic warnings.

- **Item Code:** PROTECTRANGE1
- **Valid Values:** integer value, 0 - 1000000
- **Default Value:** 300

### F.4.4 Protection Volume 1 Vertical Range [m]

#### Description

Adjusts the vertical size of the 'protection volume 1'. Inside this volume, independent from flight vectors, a certain threat level is set for any traffic target. Protection Volume 1 has the highest priority. It overrules all other protection volumes. Be very careful! Do not change this value unless you know exactly what you are doing. Adjusting this parameter wrongly may suppress traffic warnings.

- **Item Code:** PROTECTVRANGE1

- **Valid Values:** integer value, 0 - 1000000
- **Default Value:** 50

#### F.4.5 Protection Volume 1 Warnings Threat Level

##### Description

Threat level (i.e. warning severity) of a target inside the protection volume 1. Be very careful! Do not change this value unless you know exactly what you are doing. Adjusting this parameter wrongly may suppress traffic warnings or inadequately lower threat levels.

- **Item Code:** PROTECTLEVEL1
- **Valid Values:** MIN\_0, MAX\_0, MIN\_1, MAX\_1, MIN\_2, MAX\_2, MIN\_3, MAX\_3
- **Default Value:** MIN\_2

#### F.4.6 Protection Volume 2 Range [m]

##### Description

Adjusts the horizontal size of the 'protection volume 2'. Inside this volume, independent from flight vectors, a certain threat level is set for any traffic target. Protection Volume 2 has the second highest priority. It overrules all other protection volumes except protection volume 1. Be very careful! Do not change this value unless you know exactly what you are doing. Adjusting this parameter wrongly may suppress traffic warnings.

- **Item Code:** PROTECTRANGE2
- **Valid Values:** integer value, 0 - 1000000
- **Default Value:** 0

#### F.4.7 Protection Volume 2 Vertical Range [m]

##### Description

Adjusts the vertical size of the 'protection volume 2'. Inside this volume, independent from flight vectors, a certain threat level is set for any traffic target. Protection Volume 2 has the second highest priority. It overrules all other protection volumes except protection volume 1. Be very careful! Do not change this value unless you know exactly what you are doing. Adjusting this parameter wrongly may suppress traffic warnings.

- **Item Code:** PROTECTVRANGE2
- **Valid Values:** integer value, 0 - 1000000
- **Default Value:** 0

#### F.4.8 Protection Volume 2 Warnings Threat Level

## Description

Threat level (i.e. warning severity) of a target inside the protection volume 2. Be very careful! Do not change this value unless you know exactly what you are doing. Adjusting this parameter wrongly may suppress traffic warnings or inadequately lower threat levels.

- **Item Code:** PROTECTLEVEL2
- **Valid Values:** MIN\_0, MAX\_0, MIN\_1, MAX\_1, MIN\_2, MAX\_2, MIN\_3, MAX\_3
- **Default Value:** MIN\_0

### F.4.9 Protection Volume 3 Range [m]

#### Description

Adjusts the horizontal size of the 'protection volume 3'. Inside this volume, independent from flight vectors, a certain threat level is set for any traffic target. Protection Volume 3 has the second lowest priority. It only overrules protection volume 4. Be very careful! Do not change this value unless you know exactly what you are doing. Adjusting this parameter wrongly may suppress traffic warnings.

- **Item Code:** PROTECTRANGE3
- **Valid Values:** integer value, 0 - 1000000
- **Default Value:** 0

### F.4.10 Protection Volume 3 Vertical Range [m]

#### Description

Adjusts the vertical size of the 'protection volume 3'. Inside this volume, independent from flight vectors, a certain threat level is set for any traffic target. Protection Volume 3 has the second lowest priority. It only overrules protection volume 4. Be very careful! Do not change this value unless you know exactly what you are doing. Adjusting this parameter wrongly may suppress traffic warnings.

- **Item Code:** PROTECTVRANGE3
- **Valid Values:** integer value, 0 - 1000000
- **Default Value:** 0

### F.4.11 Protection Volume 3 Warnings Threat Level

#### Description

Threat level (i.e. warning severity) of a target inside the protection volume 3. Be very careful! Do not change this value unless you know exactly what you are doing. Adjusting this parameter wrongly may suppress traffic warnings or inadequately lower threat levels.

- **Item Code:** PROTECTLEVEL3
- **Valid Values:** MIN\_0, MAX\_0, MIN\_1, MAX\_1, MIN\_2, MAX\_2, MIN\_3, MAX\_3
- **Default Value:** MIN\_0

### F.4.12 Protection Volume 4 Range [m]

#### Description

Adjusts the horizontal size of the 'protection volume 4'. Inside this volume, independent from flight vectors, a certain threat level is set for any traffic target. Protection Volume 4 has the lowest priority. It is overruled by all other other protection volumes. Be very careful! Do not change this value unless you know exactly what you are doing. Adjusting this parameter wrongly may suppress traffic warnings.

- **Item Code:** PROTECTRANGE4
- **Valid Values:** integer value, 0 - 1000000
- **Default Value:** 0

### F.4.13 Protection Volume 4 Vertical Range [m]

#### Description

Adjusts the vertical size of the 'protection volume 4'. Inside this volume, independent from flight vectors, a certain threat level is set for any traffic target. Protection Volume 4 has the lowest priority. It is overruled by all other other protection volumes. Be very careful! Do not change this value unless you know exactly what you are doing. Adjusting this parameter wrongly may suppress traffic warnings.

- **Item Code:** PROTECTVRANGE4
- **Valid Values:** integer value, 0 - 1000000
- **Default Value:** 0

### F.4.14 Protection Volume 4 Warnings Threat Level

#### Description

Threat level (i.e. warning severity) of a target inside the protection volume 4. Be very careful! Do not change this value unless you know exactly what you are doing. Adjusting this parameter wrongly may suppress traffic warnings or inadequately lower threat levels.

- **Item Code:** PROTECTLEVEL4
- **Valid Values:** MIN\_0, MAX\_0, MIN\_1, MAX\_1, MIN\_2, MAX\_2, MIN\_3, MAX\_3
- **Default Value:** MIN\_0

## F.5 Digital and Analog Inputs

### F.5.1 Digital Input 1 Function

#### Description

Selects the function of the digital input 1 pin. If the pin is active, the selected function is executed. The MUTE option mutes the audio output. The NO ALARM option suppresses traffic warnings. The ON GND option triggers the 'aircraft is on the ground' state. The APPROACH option triggers the approach mode, i.e. a mode with reduced warning sensitivity. The VOICE ACKNOWLEDGE option allows to acknowledge the current spoken message.

- **Item Code:** DIN1FUNC
- **Valid Values:** UNUSED, MUTE, NOALARM, ONGND, APPROACH, VOICEACK
- **Default Value:** UNUSED

### F.5.2 Digital Input 1 Polarity

#### Description

Configures the active state of the digital input 1 pin. The input can either be active when low (pulled to GND) or when open (floating).

- **Item Code:** DIN1POL
- **Valid Values:** ACTLOW, ACTOPEN
- **Default Value:** ACTLOW

### F.5.3 Digital Input 2 Function

#### Description

Selects the function of the digital input 2 pin. If the pin is active, the selected function is executed. The MUTE option mutes the audio output. The NO ALARM option suppresses traffic warnings. The ON GND option triggers the 'aircraft is on the ground' state. The APPROACH option triggers the approach mode, i.e. a mode with reduced warning sensitivity. The VOICE ACKNOWLEDGE option allows to acknowledge the current spoken message.

- **Item Code:** DIN2FUNC
- **Valid Values:** UNUSED, MUTE, NOALARM, ONGND, APPROACH, VOICEACK
- **Default Value:** UNUSED

### F.5.4 Digital Input 2 Polarity

#### Description

Configures the active state of the digital input 2 pin. The input can either be active when low (pulled to GND) or when open (floating).

- **Item Code:** DIN2POL

- **Valid Values:** ACTLOW, ACTOPEN
- **Default Value:** ACTLOW

### F.5.5 Digital Input 3 Function

#### Description

Selects the function of the digital input 3 pin. If the pin is active, the selected function is executed. The MUTE option mutes the audio output. The NO ALARM option suppresses traffic warnings. The ON GND option triggers the 'aircraft is on the ground' state. The APPROACH option triggers the approach mode, i.e. a mode with reduced warning sensitivity. The VOICE ACKNOWLEDGE option allows to acknowledge the current spoken message.

- **Item Code:** DIN3FUNC
- **Valid Values:** UNUSED, MUTE, NOALARM, ONGND, APPROACH, VOICEACK
- **Default Value:** UNUSED

### F.5.6 Digital Input 3 Polarity

#### Description

Configures the active state of the digital input 3 pin. The input can either be active when low (pulled to GND) or when open (floating).

- **Item Code:** DIN3POL
- **Valid Values:** ACTLOW, ACTOPEN
- **Default Value:** ACTLOW

### F.5.7 Analog Input Function

#### Description

Selects the function of the analog input pin.

- **Item Code:** AIN1FUNC
- **Valid Values:** UNUSED, VOLUME
- **Default Value:** UNUSED

## F.6 Audio Output

### F.6.1 Audio Output Mode

#### Description

Selects the mode of operation for the audio output pin, i.e. the type of signals that are emitted. Off disables the audio amplifier to save power.

- **Item Code:** AUDIOMODE
- **Valid Values:** OFF, BEEP, VOICE
- **Default Value:** BEEP

### F.6.2 Audio Output Source

#### Description

Links the warning behavior of the audio output to the warning behavior of a data port. This shall always be set to the data output that is used for the primary traffic display in the aircraft.

- **Item Code:** AUDIOSRC
- **Valid Values:** PORT1, PORT2, PORT3, WIFI, ARINC429
- **Default Value:** PORT2

### F.6.3 Audio Output Volume

#### Description

Sets the volume of the audio signal emitted by the audio output pin. 100 percent means full loud. This setting has no effect if the analog input function is configured to control the audio output volume.

- **Item Code:** AUDIOVOL
- **Valid Values:** integer value, 0 - 100
- **Default Value:** 20

### F.6.4 Analog Input Pin Upper Volume Limit

#### Description

When using the analog input pin for controlling the audio volume, this value configures an upper volume limit.

- **Item Code:** AINMAXVOL
- **Valid Values:** integer value, 0 - 100
- **Default Value:** 100

## F.7 Relay

### F.7.1 Relay Mode

#### Description

Selects the mode of operation for the relay pins. The relay can be closed (contact between relay input and output pins is established) or opened (contact between input and output pins is interrupted) if targets are detected inside of the relay volume.

- **Item Code:** RELAYMODE
- **Valid Values:** UNUSED, CLOSE, OPEN
- **Default Value:** UNUSED

### F.7.2 Relay Volume Range [m]

#### Description

Sets the horizontal dimension of the 'relay volume' inside of which a target triggers the relay to be opened or closed (depending on its configuration).

- **Item Code:** RELAYRANGE
- **Valid Values:** integer value, 0 - 1000000
- **Default Value:** 1000

### F.7.3 Relay Volume Vertical Range [m]

#### Description

Sets the vertical dimension of the 'relay volume' inside of which a target triggers the relay to be opened or closed (depending on its configuration).

- **Item Code:** RELAYVRANGE
- **Valid Values:** integer value, 0 - 1000000
- **Default Value:** 100

## F.8 Flight Data Recorder

### F.8.1 Flightlog Format

#### Description

Selects the file format in use while downloading flight files onto the USB thumb drive.

- **Item Code:** FLIGHTLOGFORMAT
- **Valid Values:** IGC, KML
- **Default Value:** KML

## F.9 WiFi Interface

### F.9.1 WiFi Interface Activation

#### Description

Gives options to activate the integrated WiFi interface. If not using an in-flight WiFi data connection, we recommend setting this option to 'First 15 Minutes On'. This allows WiFi functions like the AT-1 configuration webpage to be accessed within the first 15 minutes after power-on. After 15 minutes, the WiFi interface is switched off for saving power. Be careful! Setting this option to 'Always Off' will render the AT-1 configuration webpage via WiFi inaccessible.

- **Item Code:** WIFIENABLE
- **Valid Values:** ON, 15MIN, OFF
- **Default Value:** ON

### F.9.2 WiFi Interface Flarm Traffic

#### Description

Activates or deactivates the output of Flarm traffic for this data interface.

- **Item Code:** FLARMTRAFFICW
- **Valid Values:** ON, OFF
- **Default Value:** ON

### F.9.3 WiFi Interface ADS-B Traffic

#### Description

Activates or deactivates the output of ADS-B traffic for this data interface.

- **Item Code:** ADSBTRAFFICW
- **Valid Values:** ON, OFF
- **Default Value:** ON

### F.9.4 WiFi Interface Range [m]

#### Description

Horizontal range limit. Targets outside of this range are not transmitted over this data output.

- **Item Code:** RANGEW
- **Valid Values:** integer value, 0 - 1000000
- **Default Value:** 25000

### F.9.5 WiFi Interface Vertical Range [m]

#### Description

Vertical range limit. Targets outside of this vertical range (differential altitude) are not transmitted over this data output.

- **Item Code:** VRANGEW
- **Valid Values:** integer value, 0 - 1000000
- **Default Value:** 1000

### F.9.6 WiFi Interface Non-Bearing Range [m]

#### Description

Horizontal range limit. Non-bearing targets outside of this range are not transmitted over this data output.

- **Item Code:** MODESRANGEW
- **Valid Values:** integer value, 0 - 1000000
- **Default Value:** 3000

### F.9.7 WiFi Interface Non-Bearing Vertical Range [m]

#### Description

Vertical range limit. Non-bearing targets outside of this range are not transmitted over this data output.

- **Item Code:** MODESVRANGEW
- **Valid Values:** integer value, 0 - 1000000
- **Default Value:** 500

### F.9.8 WiFi Interface Protocol

#### Description

Selects the data protocol for this data interface.

- **Item Code:** PROTOCOLW
- **Valid Values:** NMEA, GARMINTIS, GDL90, ABSTXT
- **Default Value:** NMEA

### F.9.9 WiFi Interface GPRMC

#### Description

Activates the output of the \$GPRMC dataset. GPRMC is a GPS dataset.

- **Item Code:** NMEAGPRMCW
- **Valid Values:** ON, OFF

- **Default Value:** ON

### F.9.10 WiFi Interface GPGGA

#### Description

Activates the output of the \$GPGGA dataset. GPGGA is a GPS dataset.

- **Item Code:** NMEAGPGGAW
- **Valid Values:** ON, OFF
- **Default Value:** ON

### F.9.11 WiFi Interface GPGSA

#### Description

Activates the output of the \$GPGSA dataset. GPGSA is a GPS dataset.

- **Item Code:** NMEAGPGSAW
- **Valid Values:** ON, OFF
- **Default Value:** ON

### F.9.12 WiFi Interface PGRMZ

#### Description

Activates the output of the \$PGRMZ dataset. PGRMZ is a dataset for pressure altitude.

- **Item Code:** NMEAPGRMZW
- **Valid Values:** ON, OFF
- **Default Value:** ON

### F.9.13 WiFi Interface PFLAU

#### Description

Activates the output of the \$PFLAU dataset. PFLAU is a warning dataset in the FLARM data protocol.

- **Item Code:** NMEAPFLAUW
- **Valid Values:** ON, OFF
- **Default Value:** ON

### F.9.14 WiFi Interface PFLAA

#### Description

Activates the output of the \$PFLAA dataset. PFLAA is a traffic information dataset in the FLARM data protocol.

- **Item Code:** NMEAPFLAAW

- **Valid Values:** ON, OFF
- **Default Value:** ON

### F.9.15 WiFi Interface PFLAO

#### Description

Activates the output of the \$PFLAO dataset. PFLAO is an alert zone info dataset in the FLARM data protocol.

- **Item Code:** NMEAPFLAOW
- **Valid Values:** ON, OFF
- **Default Value:** ON

### F.9.16 WiFi Interface PFLAQ

#### Description

Activates the output of the \$PFLAQ dataset. PFLAQ is a progress information dataset in the FLARM data protocol.

- **Item Code:** NMEAPFLAQW
- **Valid Values:** ON, OFF
- **Default Value:** ON

### F.9.17 WiFi Interface PFLAE

#### Description

Activates the output of the \$PFLAE dataset. PFLAE is a failure/error annunciation dataset in the FLARM data protocol.

- **Item Code:** NMEAPFLAEW
- **Valid Values:** ON, OFF
- **Default Value:** ON

### F.9.18 WiFi Interface PAAVQ

#### Description

Activates the output of the \$PAAVQ dataset. PAAVQ is a progress information dataset in the AAV data protocol.

- **Item Code:** NMEAPAAVQW
- **Valid Values:** ON, OFF
- **Default Value:** OFF

### F.9.19 WiFi Interface PAAVE

## Description

Activates the output of the \$PAAVE dataset. PAAVE is an error dataset in the AAV data protocol.

- **Item Code:** NMEAPAAVEW
- **Valid Values:** ON, OFF
- **Default Value:** OFF

## F.9.20 WiFi Interface PFLAU ID

### Description

Appends an identification data field to warning datasets in the FLARM data protocol.

- **Item Code:** NMEAPFLAUDW
- **Valid Values:** ON, OFF
- **Default Value:** ON

## F.9.21 WiFi Interface PFLAU Non-Bearing Targets

### Description

Selects how traffic warnings from non-bearing targets are transmitted over the data interface. 'Empty Bearing Field' is recommended. Only set to 'Rotate Bearing' if the connected traffic display on this interface does not support datasets with empty bearing data fields.

- **Item Code:** NMEAPFLAUNONDIRW
- **Valid Values:** OFF, EMPTYBRG, ROTATE
- **Default Value:** OFF

## F.9.22 WiFi Interface PFLAU Alert Zones

### Description

Activates warnings from FLARM alert zones.

- **Item Code:** NMEAPFLAUZONESW
- **Valid Values:** ON, OFF
- **Default Value:** ON

## F.9.23 WiFi Interface PFLAU Advisory Alerts

### Description

Activates FLARM Advisory Alerts. Advisory Alerts (also referred to as 'Info Alerts') are short traffic warning messages indicating that a target has been received for the first time within the vicinity of the own aircraft.

- **Item Code:** NMEAPFLAUADVISORYW

- **Valid Values:** ON, OFF
- **Default Value:** ON

### F.9.24 WiFi Interface PFLAA Non-Bearing Targets

#### Description

Activates data output of 'non-bearing targets' in PFLAA datasets. This is recommended if the connected traffic display on this interface does explicitly support such datasets.

- **Item Code:** NMEAPFLAAMODESW
- **Valid Values:** ON, OFF
- **Default Value:** ON

### F.9.25 WiFi Interface PFLAA No-Track Flag Output

#### Description

Activates the data output of the FLARM no-track status flag in all PFLAA datasets.

- **Item Code:** NMEAPFLAANOTRACKW
- **Valid Values:** ON, OFF
- **Default Value:** ON

### F.9.26 WiFi Interface PFLAE Error Messages

#### Description

Activates the output of error messages within the \$PFLAE dataset. In addition to the error itself, an error message is transmitted over the data port.

- **Item Code:** NMEAPFLAEMSGW
- **Valid Values:** ON, OFF
- **Default Value:** ON

### F.9.27 WiFi Interface GDL90 Send Own MSL Altitude

#### Description

The GDL90 protocol description specifies an output of the ownship GPS altitude, relative to the WGS-84 ellipsoid. The output can be changed to be relative to MSL, by activating this setting.

- **Item Code:** GDL90SENDMSLALTW
- **Valid Values:** ON, OFF
- **Default Value:** OFF

## F.10 RS-232 data port 1

### F.10.1 RS-232 data port 1 Flarm Traffic

#### Description

Activates or deactivates the output of Flarm traffic for this data interface.

- **Item Code:** FLARMTRAFFIC1
- **Valid Values:** ON, OFF
- **Default Value:** ON

### F.10.2 RS-232 data port 1 ADS-B Traffic

#### Description

Activates or deactivates the output of ADS-B traffic for this data interface.

- **Item Code:** ADSBTRAFFIC1
- **Valid Values:** ON, OFF
- **Default Value:** ON

### F.10.3 RS-232 data port 1 Range [m]

#### Description

Horizontal range limit. Targets outside of this range are not transmitted over this data output.

- **Item Code:** RANGE1
- **Valid Values:** integer value, 0 - 1000000
- **Default Value:** 25000

### F.10.4 RS-232 data port 1 Vertical Range [m]

#### Description

Vertical range limit. Targets outside of this vertical range (differential altitude) are not transmitted over this data output.

- **Item Code:** VRANGE1
- **Valid Values:** integer value, 0 - 1000000
- **Default Value:** 1000

### F.10.5 RS-232 data port 1 Non-Bearing Range [m]

#### Description

Horizontal range limit. Non-bearing targets outside of this range are not transmitted over this data output.

- **Item Code:** MODESRANGE1
- **Valid Values:** integer value, 0 - 1000000
- **Default Value:** 3000

### F.10.6 RS-232 data port 1 Non-Bearing Vertical Range [m]

#### Description

Vertical range limit. Non-bearing targets outside of this range are not transmitted over this data output.

- **Item Code:** MODESVRANGE1
- **Valid Values:** integer value, 0 - 1000000
- **Default Value:** 500

### F.10.7 RS-232 data port 1 Protocol

#### Description

Selects the data protocol for this data interface.

- **Item Code:** PROTOCOL1
- **Valid Values:** NMEA, GARMINTIS, GDL90, ABSTXT
- **Default Value:** NMEA

### F.10.8 RS-232 data port 1 RS-232 Data Rate

#### Description

Selects the RS-232 data rate (baud rate) for the RS-232 data port 1.

- **Item Code:** BAUD1
- **Valid Values:** 4800, 9600, 19200, 28800, 38400, 57600, 115200
- **Default Value:** 4800

### F.10.9 RS-232 data port 1 GPRMC

#### Description

Activates the output of the \$GPRMC dataset. GPRMC is a GPS dataset.

- **Item Code:** NMEAGPRMC1
- **Valid Values:** ON, OFF
- **Default Value:** ON

### F.10.10 RS-232 data port 1 GPGGA

#### Description

Activates the output of the \$GPGGA dataset. GPGGA is a GPS dataset.

- **Item Code:** NMEAGPGBA1
- **Valid Values:** ON, OFF
- **Default Value:** ON

#### F.10.11 RS-232 data port 1 GPGSA

##### Description

Activates the output of the \$GPGSA dataset. GPGSA is a GPS dataset.

- **Item Code:** NMEAGPGBA1
- **Valid Values:** ON, OFF
- **Default Value:** ON

#### F.10.12 RS-232 data port 1 PGRMZ

##### Description

Activates the output of the \$PGRMZ dataset. PGRMZ is a dataset for pressure altitude.

- **Item Code:** NMEAPGRMZ1
- **Valid Values:** ON, OFF
- **Default Value:** OFF

#### F.10.13 RS-232 data port 1 PFLAU

##### Description

Activates the output of the \$PFLAU dataset. PFLAU is a warning dataset in the FLARM data protocol.

- **Item Code:** NMEAPFLAU1
- **Valid Values:** ON, OFF
- **Default Value:** OFF

#### F.10.14 RS-232 data port 1 PFLAA

##### Description

Activates the output of the \$PFLAA dataset. PFLAA is a traffic information dataset in the FLARM data protocol.

- **Item Code:** NMEAPFLAA1
- **Valid Values:** ON, OFF
- **Default Value:** OFF

#### F.10.15 RS-232 data port 1 PFLAO

### Description

Activates the output of the \$PFLAO dataset. PFLAO is an alert zone info dataset in the FLARM data protocol.

- **Item Code:** NMEAPFLAO1
- **Valid Values:** ON, OFF
- **Default Value:** OFF

### F.10.16 RS-232 data port 1 PFLAQ

#### Description

Activates the output of the \$PFLAQ dataset. PFLAQ is a progress information dataset in the FLARM data protocol.

- **Item Code:** NMEAPFLAQ1
- **Valid Values:** ON, OFF
- **Default Value:** OFF

### F.10.17 RS-232 data port 1 PFLAE

#### Description

Activates the output of the \$PFLAE dataset. PFLAE is a failure/error annunciation dataset in the FLARM data protocol.

- **Item Code:** NMEAPFLAE1
- **Valid Values:** ON, OFF
- **Default Value:** OFF

### F.10.18 RS-232 data port 1 PAAVQ

#### Description

Activates the output of the \$PAAVQ dataset. PAAVQ is a progress information dataset in the AAV data protocol.

- **Item Code:** NMEAPAAVQ1
- **Valid Values:** ON, OFF
- **Default Value:** OFF

### F.10.19 RS-232 data port 1 PAAVE

#### Description

Activates the output of the \$PAAVE dataset. PAAVE is an error dataset in the AAV data protocol.

- **Item Code:** NMEAPAAVE1

- **Valid Values:** ON, OFF
- **Default Value:** OFF

### F.10.20 RS-232 data port 1 PFLAU ID

#### Description

Appends an identification data field to warning datasets in the FLARM data protocol.

- **Item Code:** NMEAPFLAUID1
- **Valid Values:** ON, OFF
- **Default Value:** ON

### F.10.21 RS-232 data port 1 PFLAU Non-Bearing Targets

#### Description

Selects how traffic warnings from non-bearing targets are transmitted over the data interface. 'Empty Bearing Field' is recommended. Only set to 'Rotate Bearing' if the connected traffic display on this interface does not support datasets with empty bearing data fields.

- **Item Code:** NMEAPFLAUNONDIR1
- **Valid Values:** OFF, EMPTYBRG, ROTATE
- **Default Value:** OFF

### F.10.22 RS-232 data port 1 PFLAU Alert Zones

#### Description

Activates warnings from FLARM alert zones.

- **Item Code:** NMEAPFLAUZONES1
- **Valid Values:** ON, OFF
- **Default Value:** ON

### F.10.23 RS-232 data port 1 PFLAU Advisory Alerts

#### Description

Activates FLARM Advisory Alerts. Advisory Alerts (also referred to as 'Info Alerts') are short traffic warning messages indicating that a target has been received for the first time within the vicinity of the own aircraft.

- **Item Code:** NMEAPFLAUADVISORY1
- **Valid Values:** ON, OFF
- **Default Value:** ON

### F.10.24 RS-232 data port 1 PFLAA Non-Bearing Targets

### Description

Activates data output of 'non-bearing targets' in PFLAA datasets. This is recommended if the connected traffic display on this interface does explicitly support such datasets.

- **Item Code:** NMEAPFLAAMODES1
- **Valid Values:** ON, OFF
- **Default Value:** ON

## F.10.25 RS-232 data port 1 PFLAA No-Track Flag Output

### Description

Activates the data output of the FLARM no-track status flag in all PFLAA datasets.

- **Item Code:** NMEAPFLAANOTRACK1
- **Valid Values:** ON, OFF
- **Default Value:** ON

## F.10.26 RS-232 data port 1 PFLAE Error Messages

### Description

Activates the output of error messages within the \$PFLAE dataset. In addition to the error itself, an error message is transmitted over the data port.

- **Item Code:** NMEAPFLAEMSG1
- **Valid Values:** ON, OFF
- **Default Value:** ON

## F.10.27 RS-232 data port 1 GDL90 Send Own MSL Altitude

### Description

The GDL90 protocol description specifies an output of the ownship GPS altitude, relative to the WGS-84 ellipsoid. The output can be changed to be relative to MSL, by activating this setting.

- **Item Code:** GDL90SENDMSLALT1
- **Valid Values:** ON, OFF
- **Default Value:** OFF

## F.11 RS-232 data port 2

### F.11.1 RS-232 data port 2 Flarm Traffic

#### Description

Activates or deactivates the output of Flarm traffic for this data interface.

- **Item Code:** FLARMTRAFFIC2
- **Valid Values:** ON, OFF
- **Default Value:** ON

### F.11.2 RS-232 data port 2 ADS-B Traffic

#### Description

Activates or deactivates the output of ADS-B traffic for this data interface.

- **Item Code:** ADSBTRAFFIC2
- **Valid Values:** ON, OFF
- **Default Value:** ON

### F.11.3 RS-232 data port 2 Range [m]

#### Description

Horizontal range limit. Targets outside of this range are not transmitted over this data output.

- **Item Code:** RANGE2
- **Valid Values:** integer value, 0 - 1000000
- **Default Value:** 25000

### F.11.4 RS-232 data port 2 Vertical Range [m]

#### Description

Vertical range limit. Targets outside of this vertical range (differential altitude) are not transmitted over this data output.

- **Item Code:** VRANGE2
- **Valid Values:** integer value, 0 - 1000000
- **Default Value:** 1000

### F.11.5 RS-232 data port 2 Non-Bearing Range [m]

#### Description

Horizontal range limit. Non-bearing targets outside of this range are not transmitted over this data output.

- **Item Code:** MODESRANGE2
- **Valid Values:** integer value, 0 - 1000000
- **Default Value:** 3000

### F.11.6 RS-232 data port 2 Non-Bearing Vertical Range [m]

#### Description

Vertical range limit. Non-bearing targets outside of this range are not transmitted over this data output.

- **Item Code:** MODESVRANGE2
- **Valid Values:** integer value, 0 - 1000000
- **Default Value:** 500

### F.11.7 RS-232 data port 2 Protocol

#### Description

Selects the data protocol for this data interface.

- **Item Code:** PROTOCOL2
- **Valid Values:** NMEA, GARMINTIS, GDL90, ABSTXT
- **Default Value:** NMEA

### F.11.8 RS-232 data port 2 RS-232 Data Rate

#### Description

Selects the RS-232 data rate (baud rate) for the RS-232 data port 2.

- **Item Code:** BAUD2
- **Valid Values:** 4800, 9600, 19200, 28800, 38400, 57600, 115200
- **Default Value:** 19200

### F.11.9 RS-232 data port 2 GPRMC

#### Description

Activates the output of the \$GPRMC dataset. GPRMC is a GPS dataset.

- **Item Code:** NMEAGPRMC2
- **Valid Values:** ON, OFF
- **Default Value:** ON

### F.11.10 RS-232 data port 2 GPGGA

#### Description

Activates the output of the \$GPGGA dataset. GPGGA is a GPS dataset.

- **Item Code:** NMEAGPGBA2
- **Valid Values:** ON, OFF
- **Default Value:** ON

#### F.11.11 RS-232 data port 2 GPGSA

##### Description

Activates the output of the \$GPGSA dataset. GPGSA is a GPS dataset.

- **Item Code:** NMEAGPGBA2
- **Valid Values:** ON, OFF
- **Default Value:** ON

#### F.11.12 RS-232 data port 2 PGRMZ

##### Description

Activates the output of the \$PGRMZ dataset. PGRMZ is a dataset for pressure altitude.

- **Item Code:** NMEAPGRMZ2
- **Valid Values:** ON, OFF
- **Default Value:** ON

#### F.11.13 RS-232 data port 2 PFLAU

##### Description

Activates the output of the \$PFLAU dataset. PFLAU is a warning dataset in the FLARM data protocol.

- **Item Code:** NMEAPFLAU2
- **Valid Values:** ON, OFF
- **Default Value:** ON

#### F.11.14 RS-232 data port 2 PFLAA

##### Description

Activates the output of the \$PFLAA dataset. PFLAA is a traffic information dataset in the FLARM data protocol.

- **Item Code:** NMEAPFLAA2
- **Valid Values:** ON, OFF
- **Default Value:** ON

#### F.11.15 RS-232 data port 2 PFLAO

### Description

Activates the output of the \$PFLAO dataset. PFLAO is an alert zone info dataset in the FLARM data protocol.

- **Item Code:** NMEAPFLAO2
- **Valid Values:** ON, OFF
- **Default Value:** ON

### F.11.16 RS-232 data port 2 PFLAQ

#### Description

Activates the output of the \$PFLAQ dataset. PFLAQ is a progress information dataset in the FLARM data protocol.

- **Item Code:** NMEAPFLAQ2
- **Valid Values:** ON, OFF
- **Default Value:** ON

### F.11.17 RS-232 data port 2 PFLAE

#### Description

Activates the output of the \$PFLAE dataset. PFLAE is a failure/error annunciation dataset in the FLARM data protocol.

- **Item Code:** NMEAPFLAE2
- **Valid Values:** ON, OFF
- **Default Value:** ON

### F.11.18 RS-232 data port 2 PAAVQ

#### Description

Activates the output of the \$PAAVQ dataset. PAAVQ is a progress information dataset in the AAV data protocol.

- **Item Code:** NMEAPAAVQ2
- **Valid Values:** ON, OFF
- **Default Value:** OFF

### F.11.19 RS-232 data port 2 PAAVE

#### Description

Activates the output of the \$PAAVE dataset. PAAVE is an error dataset in the AAV data protocol.

- **Item Code:** NMEAPAAVE2

- **Valid Values:** ON, OFF
- **Default Value:** OFF

### F.11.20 RS-232 data port 2 PFLAU ID

#### Description

Appends an identification data field to warning datasets in the FLARM data protocol.

- **Item Code:** NMEAPFLAUID2
- **Valid Values:** ON, OFF
- **Default Value:** ON

### F.11.21 RS-232 data port 2 PFLAU Non-Bearing Targets

#### Description

Selects how traffic warnings from non-bearing targets are transmitted over the data interface. 'Empty Bearing Field' is recommended. Only set to 'Rotate Bearing' if the connected traffic display on this interface does not support datasets with empty bearing data fields.

- **Item Code:** NMEAPFLAUNONDIR2
- **Valid Values:** OFF, EMPTYBRG, ROTATE
- **Default Value:** OFF

### F.11.22 RS-232 data port 2 PFLAU Alert Zones

#### Description

Activates warnings from FLARM alert zones.

- **Item Code:** NMEAPFLAUZONES2
- **Valid Values:** ON, OFF
- **Default Value:** ON

### F.11.23 RS-232 data port 2 PFLAU Advisory Alerts

#### Description

Activates FLARM Advisory Alerts. Advisory Alerts (also referred to as 'Info Alerts') are short traffic warning messages indicating that a target has been received for the first time within the vicinity of the own aircraft.

- **Item Code:** NMEAPFLAUADVISORY2
- **Valid Values:** ON, OFF
- **Default Value:** ON

### F.11.24 RS-232 data port 2 PFLAA Non-Bearing Targets

### Description

Activates data output of 'non-bearing targets' in PFLAA datasets. This is recommended if the connected traffic display on this interface does explicitly support such datasets.

- **Item Code:** NMEAPFLAAMODES2
- **Valid Values:** ON, OFF
- **Default Value:** ON

### F.11.25 RS-232 data port 2 PFLAA No-Track Flag Output

#### Description

Activates the data output of the FLARM no-track status flag in all PFLAA datasets.

- **Item Code:** NMEAPFLAANOTRACK2
- **Valid Values:** ON, OFF
- **Default Value:** ON

### F.11.26 RS-232 data port 2 PFLAE Error Messages

#### Description

Activates the output of error messages within the \$PFLAE dataset. In addition to the error itself, an error message is transmitted over the data port.

- **Item Code:** NMEAPFLAEMSG2
- **Valid Values:** ON, OFF
- **Default Value:** ON

### F.11.27 RS-232 data port 2 GDL90 Send Own MSL Altitude

#### Description

The GDL90 protocol description specifies an output of the ownship GPS altitude, relative to the WGS-84 ellipsoid. The output can be changed to be relative to MSL, by activating this setting.

- **Item Code:** GDL90SENDMSLALT2
- **Valid Values:** ON, OFF
- **Default Value:** OFF

## F.12 RS-232 data port 3

### F.12.1 RS-232 data port 3 Flarm Traffic

#### Description

Activates or deactivates the output of Flarm traffic for this data interface.

- **Item Code:** FLARMTRAFFIC3
- **Valid Values:** ON, OFF
- **Default Value:** ON

### F.12.2 RS-232 data port 3 ADS-B Traffic

#### Description

Activates or deactivates the output of ADS-B traffic for this data interface.

- **Item Code:** ADSBTRAFFIC3
- **Valid Values:** ON, OFF
- **Default Value:** ON

### F.12.3 RS-232 data port 3 Range [m]

#### Description

Horizontal range limit. Targets outside of this range are not transmitted over this data output.

- **Item Code:** RANGE3
- **Valid Values:** integer value, 0 - 1000000
- **Default Value:** 25000

### F.12.4 RS-232 data port 3 Vertical Range [m]

#### Description

Vertical range limit. Targets outside of this vertical range (differential altitude) are not transmitted over this data output.

- **Item Code:** VRANGE3
- **Valid Values:** integer value, 0 - 1000000
- **Default Value:** 1000

### F.12.5 RS-232 data port 3 Non-Bearing Range [m]

#### Description

Horizontal range limit. Non-bearing targets outside of this range are not transmitted over this data output.

- **Item Code:** MODESRANGE3
- **Valid Values:** integer value, 0 - 1000000
- **Default Value:** 3000

### F.12.6 RS-232 data port 3 Non-Bearing Vertical Range [m]

#### Description

Vertical range limit. Non-bearing targets outside of this range are not transmitted over this data output.

- **Item Code:** MODESVRANGE3
- **Valid Values:** integer value, 0 - 1000000
- **Default Value:** 500

### F.12.7 RS-232 data port 3 Protocol

#### Description

Selects the data protocol for this data interface.

- **Item Code:** PROTOCOL3
- **Valid Values:** NMEA, GARMINTIS, GDL90, ABSTXT
- **Default Value:** GARMINTIS

### F.12.8 RS-232 data port 3 RS-232 Data Rate

#### Description

Selects the RS-232 data rate (baud rate) for the RS-232 data port 3.

- **Item Code:** BAUD3
- **Valid Values:** 4800, 9600, 19200, 28800, 38400, 57600, 115200
- **Default Value:** 9600

### F.12.9 RS-232 data port 3 GPRMC

#### Description

Activates the output of the \$GPRMC dataset. GPRMC is a GPS dataset.

- **Item Code:** NMEAGPRMC3
- **Valid Values:** ON, OFF
- **Default Value:** ON

### F.12.10 RS-232 data port 3 GPGGA

#### Description

Activates the output of the \$GPGGA dataset. GPGGA is a GPS dataset.

- **Item Code:** NMEAGPGGA3
- **Valid Values:** ON, OFF
- **Default Value:** ON

#### F.12.11 RS-232 data port 3 GPGSA

##### Description

Activates the output of the \$GPGSA dataset. GPGSA is a GPS dataset.

- **Item Code:** NMEAGPGSA3
- **Valid Values:** ON, OFF
- **Default Value:** ON

#### F.12.12 RS-232 data port 3 PGRMZ

##### Description

Activates the output of the \$PGRMZ dataset. PGRMZ is a dataset for pressure altitude.

- **Item Code:** NMEAPGRMZ3
- **Valid Values:** ON, OFF
- **Default Value:** ON

#### F.12.13 RS-232 data port 3 PFLAU

##### Description

Activates the output of the \$PFLAU dataset. PFLAU is a warning dataset in the FLARM data protocol.

- **Item Code:** NMEAPFLAU3
- **Valid Values:** ON, OFF
- **Default Value:** ON

#### F.12.14 RS-232 data port 3 PFLAA

##### Description

Activates the output of the \$PFLAA dataset. PFLAA is a traffic information dataset in the FLARM data protocol.

- **Item Code:** NMEAPFLAA3
- **Valid Values:** ON, OFF
- **Default Value:** ON

#### F.12.15 RS-232 data port 3 PFLAO

### Description

Activates the output of the \$PFLAO dataset. PFLAO is an alert zone info dataset in the FLARM data protocol.

- **Item Code:** NMEAPFLAO3
- **Valid Values:** ON, OFF
- **Default Value:** ON

### F.12.16 RS-232 data port 3 PFLAQ

#### Description

Activates the output of the \$PFLAQ dataset. PFLAQ is a progress information dataset in the FLARM data protocol.

- **Item Code:** NMEAPFLAQ3
- **Valid Values:** ON, OFF
- **Default Value:** ON

### F.12.17 RS-232 data port 3 PFLAE

#### Description

Activates the output of the \$PFLAE dataset. PFLAE is a failure/error annunciation dataset in the FLARM data protocol.

- **Item Code:** NMEAPFLAE3
- **Valid Values:** ON, OFF
- **Default Value:** ON

### F.12.18 RS-232 data port 3 PAAVQ

#### Description

Activates the output of the \$PAAVQ dataset. PAAVQ is a progress information dataset in the AAV data protocol.

- **Item Code:** NMEAPAAVQ3
- **Valid Values:** ON, OFF
- **Default Value:** ON

### F.12.19 RS-232 data port 3 PAAVE

#### Description

Activates the output of the \$PAAVE dataset. PAAVE is an error dataset in the AAV data protocol.

- **Item Code:** NMEAPAAVE3

- **Valid Values:** ON, OFF
- **Default Value:** ON

### F.12.20 RS-232 data port 3 PFLAU ID

#### Description

Appends an identification data field to warning datasets in the FLARM data protocol.

- **Item Code:** NMEAPFLAUID3
- **Valid Values:** ON, OFF
- **Default Value:** ON

### F.12.21 RS-232 data port 3 PFLAU Non-Bearing Targets

#### Description

Selects how traffic warnings from non-bearing targets are transmitted over the data interface. 'Empty Bearing Field' is recommended. Only set to 'Rotate Bearing' if the connected traffic display on this interface does not support datasets with empty bearing data fields.

- **Item Code:** NMEAPFLAUNONDIR3
- **Valid Values:** OFF, EMPTYBRG, ROTATE
- **Default Value:** OFF

### F.12.22 RS-232 data port 3 PFLAU Alert Zones

#### Description

Activates warnings from FLARM alert zones.

- **Item Code:** NMEAPFLAUZONES3
- **Valid Values:** ON, OFF
- **Default Value:** ON

### F.12.23 RS-232 data port 3 PFLAU Advisory Alerts

#### Description

Activates FLARM Advisory Alerts. Advisory Alerts (also referred to as 'Info Alerts') are short traffic warning messages indicating that a target has been received for the first time within the vicinity of the own aircraft.

- **Item Code:** NMEAPFLAUADVISORY3
- **Valid Values:** ON, OFF
- **Default Value:** ON

### F.12.24 RS-232 data port 3 PFLAA Non-Bearing Targets

### Description

Activates data output of 'non-bearing targets' in PFLAA datasets. This is recommended if the connected traffic display on this interface does explicitly support such datasets.

- **Item Code:** NMEAPFLAAMODES3
- **Valid Values:** ON, OFF
- **Default Value:** ON

## F.12.25 RS-232 data port 3 PFLAA No-Track Flag Output

### Description

Activates the data output of the FLARM no-track status flag in all PFLAA datasets.

- **Item Code:** NMEAPFLAANOTRACK3
- **Valid Values:** ON, OFF
- **Default Value:** ON

## F.12.26 RS-232 data port 3 PFLAE Error Messages

### Description

Activates the output of error messages within the \$PFLAE dataset. In addition to the error itself, an error message is transmitted over the data port.

- **Item Code:** NMEAPFLAEMSG3
- **Valid Values:** ON, OFF
- **Default Value:** ON

## F.12.27 RS-232 data port 3 GDL90 Send Own MSL Altitude

### Description

The GDL90 protocol description specifies an output of the ownship GPS altitude, relative to the WGS-84 ellipsoid. The output can be changed to be relative to MSL, by activating this setting.

- **Item Code:** GDL90SENDMSLALT3
- **Valid Values:** ON, OFF
- **Default Value:** OFF

## F.13 ARINC 429 Interface

### F.13.1 ARINC429 Flarm Traffic

#### Description

Activates or deactivates the output of Flarm traffic data over the ARINC429 data output.

- **Item Code:** A429FLARMTRAFFIC
- **Valid Values:** ON, OFF
- **Default Value:** ON

### F.13.2 ARINC429 ADS-B Traffic

#### Description

Activates or deactivates the output of ADS-B traffic data over the ARINC429 data output.

- **Item Code:** A429ADSBTRAFFIC
- **Valid Values:** ON, OFF
- **Default Value:** ON

### F.13.3 ARINC429 Range [m]

#### Description

Horizontal range limit. Targets outside of this range are not transmitted over the ARINC429 data output.

- **Item Code:** A429RANGE
- **Valid Values:** integer value, 0 - 1000000
- **Default Value:** 25000

### F.13.4 ARINC429 Vertical Range [m]

#### Description

Vertical range limit. Targets outside of this range are not transmitted over the ARINC429 data output.

- **Item Code:** A429VRANGE
- **Valid Values:** integer value, 0 - 1000000
- **Default Value:** 1000

### F.13.5 ARINC429 Non-Bearing Range [m]

#### Description

Horizontal range limit. Non-bearing targets outside of this range are not transmitted over the ARINC429 data output.

- **Item Code:** A429MODESRANGE
- **Valid Values:** integer value, 0 - 1000000
- **Default Value:** 3000

### F.13.6 ARINC429 Non-Bearing Vertical Range [m]

#### Description

Vertical range limit. Non-bearing targets outside of this range are not transmitted over the ARINC429 data output.

- **Item Code:** A429MODESVRANGE
- **Valid Values:** integer value, 0 - 1000000
- **Default Value:** 500

### F.13.7 ARINC429 Send Heading

#### Description

Some ARINC429 systems displaying traffic do require heading data in order to display traffic correctly on their moving-map screens. If this option is activated, AT-1 transmits a GPS-track-derived aircraft heading over the ARINC429 data output. Under circumstances, for example, when the own aircraft is not moving, this heading data is inaccurate or even wrong. Be very careful! Heading data may be used for displaying traffic data from AT-1 only. Do not activate this feature if you are unsure of where the heading data is used.

- **Item Code:** A429SENDHDG
- **Valid Values:** ON, OFF
- **Default Value:** OFF

### F.13.8 ARINC429 Company ID

#### Description

Configures the ARINC429 Company Identifier, a device identification message, transmitted over the ARINC429 data output.

- **Item Code:** A429COMPANYID
- **Valid Values:** 2-digit hex number, 0 - 3F
- **Default Value:** 1B

## G.1 AT-1 Software Version 23

### G.1.1 Component Versions

---

<i>Main Module Software Version:</i>	18
<i>WiFi Module Software Version:</i>	3
<i>FLARM Module Software Version:</i>	7.09
<i>1090MHz Receiver Module Software Version:</i>	42

---

This version will only update AT-1 Serial devices which currently run version 21 or 22. On devices running version 16 this update is not possible.

### G.1.2 Changes Since Version 22

#### Main Module Software

This image contains main module software version 18. From version 17 minor bugfixes have been made.

#### WiFi Module Software

This image contains firmware version 3 for the WiFi module. For a detailed description please see below.

#### FLARM Module Software

- Updated FLARM core software from version 7.04 to version 7.09.

#### 1090MHz Receiver Module Software

This image contains version 42 for the 1090MHz receiver module.

## G.2 AT-1 Software Version 22

### G.2.1 Component Versions

---

<i>Main Module Software Version:</i>	22
<i>WiFi Module Software Version:</i>	3
<i>FLARM Module Software Version:</i>	7.04
<i>1090MHz Receiver Module Software Version:</i>	42

---

### G.2.2 Changes Since Version 21

#### Main Module Software

This image contains main module software version 22. From version 21 changes have been made. This version will only update AT-1 Serial number 1800 or later which currently run version 21. On devices running version 16 the update is not possible. There are no functional differences between version 16 and 22.

#### WiFi Module Software

This image contains firmware version 3 for the WiFi module. For a detailed description please see below.

#### FLARM Module Software

- Updated FLARM core software from version 7.01 to version 7.04.

#### 1090MHz Receiver Module Software

This image contains version 42 for the 1090MHz receiver module.

## G.3 AT-1 Software Version 21

### G.3.1 Component Versions

---

<i>Main Module Software Version:</i>	21
<i>WiFi Module Software Version:</i>	-
<i>FLARM Module Software Version:</i>	7.01
<i>1090MHz Receiver Module Software Version:</i>	-

---

### G.3.2 Changes Since Version 16

#### Main Module Software

There have been no functional changes since version 16. This version has only been created to facilitate internal hardware changes of a new production lot from serial number 1800 upwards.

#### WiFi Module Software

This image contains no firmware for the WiFi module.

#### FLARM Module Software

- FLARM core software version 7.01.

#### 1090MHz Receiver Module Software

This image contains no firmware for the 1090MHz receiver module.

## G.4 AT-1 Software Version 18

Please be careful: If using an AIR Traffic Display on your AT-1, please ensure that the AIR Traffic Display is updated to version 21 or later before updating your AT-1 to this version!

### G.4.1 Component Versions

<i>Main Module Software Version:</i>	18
<i>WiFi Module Software Version:</i>	-
<i>FLARM Module Software Version:</i>	7.09
<i>1090MHz Receiver Module Software Version:</i>	-

### G.4.2 Changes Since Version 17

#### Main Module Software

This image contains main module software version 18. From version 17 minor bugfixes have been made.

#### WiFi Module Software

This image contains no firmware for the WiFi module.

#### FLARM Module Software

- Updated FLARM core software from version 7.04 to version 7.09.

#### 1090MHz Receiver Module Software

This image contains no firmware for the 1090MHz receiver module.

## G.5 AT-1 Software Version 16

Please be careful: If using an AIR Traffic Display on your AT-1, please ensure that the AIR Traffic Display is updated to version 21 or later before updating your AT-1 to this version!

### G.5.1 Component Versions

---

<i>Main Module Software Version:</i>	16
<i>WiFi Module Software Version:</i>	-
<i>FLARM Module Software Version:</i>	7.04
<i>1090MHz Receiver Module Software Version:</i>	-

---

### G.5.2 Changes Since Version 15

#### Main Module Software

- Handle additional error cases during updates of the submodules.

#### WiFi Module Software

This image contains no firmware for the WiFi module.

#### FLARM Module Software

- Updated FLARM core software from version 7.01 to version 7.04.

#### 1090MHz Receiver Module Software

This image contains no firmware for the 1090MHz receiver module.

## G.6 AT-1 Software Version 15

Please be careful: If using an AIR Traffic Display on your AT-1, please ensure that the AIR Traffic Display is updated to version 21 or later before updating your AT-1 to this version!

### G.6.1 Component Versions

---

<i>Main Module Software Version:</i>	13
<i>WiFi Module Software Version:</i>	-
<i>FLARM Module Software Version:</i>	7.01
<i>1090MHz Receiver Module Software Version:</i>	-

---

### G.6.2 Changes Since Version 12

#### Main Module Software

- Handle additional error cases during updates of the submodules.

#### WiFi Module Software

This image contains no firmware for the WiFi module.

#### FLARM Module Software

No Changes.

#### 1090MHz Receiver Module Software

This image contains no firmware for the 1090MHz receiver module.

## G.7 AT-1 Software Version 12

Please be careful: If using an AIR Traffic Display on your AT-1, please ensure that the AIR Traffic Display is updated to version 21 or later before updating your AT-1 to this version!

### G.7.1 Component Versions

---

<i>Main Module Software Version:</i>	10
<i>WiFi Module Software Version:</i>	-
<i>FLARM Module Software Version:</i>	7.01
<i>1090MHz Receiver Module Software Version:</i>	-

---

### G.7.2 Changes Since Version 11

#### Main Module Software

- Added output of container sw version (SWVER) to info file.

#### WiFi Module Software

This image contains no firmware for the WiFi module.

#### FLARM Module Software

No Changes.

#### 1090MHz Receiver Module Software

This image contains no firmware for the 1090MHz receiver module.

## G.8 AT-1 Software Version 11

Please be careful: If using an AIR Traffic Display on your AT-1, please ensure that the AIR Traffic Display is updated to version 21 or later before updating your AT-1 to this version!

### G.8.1 Component Versions

<i>Main Module Software Version:</i>	9
<i>WiFi Module Software Version:</i>	-
<i>FLARM Module Software Version:</i>	7.01
<i>1090MHz Receiver Module Software Version:</i>	-

### G.8.2 Changes Since Version 10

#### Main Module Software

- Disable output of warning 0x6A if wifi firmware is missing on flash memory.

#### WiFi Module Software

This image contains no firmware for the WiFi module.

#### FLARM Module Software

No Changes.

#### 1090MHz Receiver Module Software

This image contains no firmware for the 1090MHz receiver module.

## G.9 AT-1 Software Version 10

Please be careful: If using an AIR Traffic Display on your AT-1, please ensure that the AIR Traffic Display is updated to version 21 or later before updating your AT-1 to this version!

### G.9.1 Component Versions

---

<i>Main Module Software Version:</i>	8
<i>WiFi Module Software Version:</i>	-
<i>FLARM Module Software Version:</i>	7.01
<i>1090MHz Receiver Module Software Version:</i>	-

---

### G.9.2 Changes Since Version 9

#### Main Module Software

- Improved Flarm firmware update code.

#### WiFi Module Software

This image contains no firmware for the WiFi module.

#### FLARM Module Software

- Updated FLARM core software from version 6.80 to version 7.01.

#### 1090MHz Receiver Module Software

This image contains no firmware for the 1090MHz receiver module.

## G.10 AT-1 Software Version 9

Please be careful: If using an AIR Traffic Display on your AT-1, please ensure that the AIR Traffic Display is updated to version 21 or later before updating your AT-1 to this version!

### G.10.1 Component Versions

---

<i>Main Module Software Version:</i>	7
<i>WiFi Module Software Version:</i>	3
<i>FLARM Module Software Version:</i>	6.80
<i>1090MHz Receiver Module Software Version:</i>	-

---

### G.10.2 Changes Since Version 8

#### Main Module Software

- Support for hardware versions xxx1 (housing version 1)

#### WiFi Module Software

No Changes.

#### FLARM Module Software

No Changes.

#### 1090MHz Receiver Module Software

No Changes.

## G.11 AT-1 Software Version 8

Please be careful: If using an AIR Traffic Display on your AT-1, please ensure that the AIR Traffic Display is updated to version 21 or later before updating your AT-1 to this version!

### G.11.1 Component Versions

---

<i>Main Module Software Version:</i>	6
<i>WiFi Module Software Version:</i>	3
<i>FLARM Module Software Version:</i>	6.80
<i>1090MHz Receiver Module Software Version:</i>	-

---

### G.11.2 Changes Since Version 7

#### Main Module Software

- Fixed an issue which could result in invalid altitude output in GDL90 protocol.
- Fixed an issue which could result in missing relay output functionality after change of configuration.

#### WiFi Module Software

No Changes.

#### FLARM Module Software

No Changes.

#### 1090MHz Receiver Module Software

No Changes.

## G.12 AT-1 Software Version 7

Please be careful: If using an AIR Traffic Display on your AT-1, please ensure that the AIR Traffic Display is updated to version 21 or later before updating your AT-1 to this version!

### G.12.1 Component Versions

<i>Main Module Software Version:</i>	-
<i>WiFi Module Software Version:</i>	-
<i>FLARM Module Software Version:</i>	-
<i>1090MHz Receiver Module Software Version:</i>	42

### G.12.2 Changes Since Version 6

This software version only contains firmware for the integrated 1090MHz receiver module and can be applied any time.

#### Main Module Software

This image contains no firmware for the main module.

#### WiFi Module Software

This image contains no firmware for the WiFi module.

#### FLARM Module Software

This image contains no firmware for the Flarm module.

#### 1090MHz Receiver Module Software

- Fixed an issue, which could result in reduced transponder reception capabilities in combination with certain startup conditions.

## G.13 AT-1 Software Version 6

Please be careful: If using an AIR Traffic Display on your AT-1, please ensure that the AIR Traffic Display is updated to version 21 or later before updating your AT-1 to this version!

### G.13.1 Component Versions

---

<i>Main Module Software Version:</i>	5
<i>WiFi Module Software Version:</i>	3
<i>FLARM Module Software Version:</i>	6.80
<i>1090MHz Receiver Module Software Version:</i>	38

---

### G.13.2 Changes Since Version 5

#### Main Module Software

- Fixed a minor issue in the trx module production test.

#### WiFi Module Software

No Changes.

#### FLARM Module Software

- Updated FLARM core software from version 6.62 to version 6.80.

#### 1090MHz Receiver Module Software

No Changes

## G.14 AT-1 Software Version 5

Please be careful: If using an AIR Traffic Display on your AT-1, please ensure that the AIR Traffic Display is updated to version 21 or later before updating your AT-1 to this version!

### G.14.1 Component Versions

<i>Main Module Software Version:</i>	4
<i>WiFi Module Software Version:</i>	3
<i>FLARM Module Software Version:</i>	6.62
<i>1090MHz Receiver Module Software Version:</i>	38

### G.14.2 Changes Since Version 4

#### Main Module Software

- Added flight data recording in IGC and KML format.
- Added absolute data output.
- Added persistent error log, which can be read out via USB stick.
- Added progress output for longrunning initialization tasks.
- Added GPSTRKFALLBACK configuration item to select GPS track, if no GPS based track is available (e.g. when not moving).
- Added three additional protection volume configuration items (PROTECTRANGEn, PROTECTVRANGEn, PROTECTLEVELn) for configuration of warning behaviour within four volumes.
- Added REQUESTCONFIG command item to read device configuration at once.
- Added handling of static object FLARM targets.
- Increased audio voice volume.
- Fixed an error when printing FLARM acft type values greater than 9 (use hex encoding).
- Fixed an error when generating audio output synchronous to ARINC, GarminTIS or GDL90 output.

#### WiFi Module Software

- Added ui elements for GPSTRKFALLBACK to the config website.
- Added ui elements for additional protection volume items to the config website.
- Added ui elements for flight data recording to the config website.
- Added ui elements for absolute data output to the config website.
- Added buttons to clear Flarm obstacle database to the config website.
- Added buttons to clear flight log memory to the config website.

- Added button to perform a factory reset to the config website.
- Reordered ARINC429 interface items on the config website to be consistent to logfile.
- Show FLARM radio-id type on the config website.
- Show FLARM obstacle db status on the config website.
- Corrected description of WARNONGND item on the config website.
- Improved naming of items on the config website.
- Fixed an error when selecting 5V GPS antenna supply voltage.

#### FLARM Module Software

No Changes.

#### 1090MHz Receiver Module Software

No Changes.

## G.15 AT-1 Software Version 4

### G.15.1 Component Versions

---

<i>Main Module Software Version:</i>	3
<i>WiFi Module Software Version:</i>	2
<i>FLARM Module Software Version:</i>	6.62
<i>1090MHz Receiver Module Software Version:</i>	38

---

### G.15.2 Changes Since Version 3

#### Main Module Software

- Added support for hardware version 1100, 1000 and 0100.

#### WiFi Module Software

No Changes.

#### FLARM Module Software

No Changes.

#### 1090MHz Receiver Module Software

No Changes.

## G.16 AT1 Software Version 3

### G.16.1 Component Versions

<i>Main Module Software Version:</i>	2
<i>WiFi Module Software Version:</i>	2
<i>FLARM Module Software Version:</i>	6.62
<i>1090MHz Receiver Module Software Version:</i>	38

### G.16.2 Changes Since Version 2

#### Main Module Software

- Added GDL90 data output.
- Added voice functions for alarm and error announcement via audio output.
- Added functionality (input pins and serial commands) to acknowledge errors and alarms.
- Added FLARMTRAFFIC and ADSBTRAFFIC filter settings to all available data output channels.
- Added additional scenarios to GPS simulator, e.g. to simulate bad GPS reception.
- Added simple port config items, to allow easy selection of specific device (e.g. 'FLARM').
- Use ONGND switch to force FLARM flight state.
- Disable FLARM or 1090 receiver maintenance functions while AT-1 is in simulator mode.
- Fixed minor bugs in the ARINC429 output. Deactivated TCASActive flag if no GPS track is available.
- Removed NONONDIRALARM digital input function.
- Added command to trigger an audio test sound.
- Added more detailed titles to info logfile. Reordered config items in logfile to be consistent to configuration webpage.

#### WiFi Module Software

- Added UDP broadcast for GDL90 data.
- Improved loading speed of config website.
- Removed separate streaming website to improve the stability of the integrated web server.
- Show FLARM radio-id type and FLARM obstacle db status on config website.
- Added button to test audio out functionality to config websites Audio Out section.
- Added button to perform a factory reset to the expert-mode configuration webpage.

- Improved naming of items on the configuration webpage.
- Reordered ARINC429 interface items on configuration webpage to be consistent to logfile.

#### FLARM Module Software

- Updated FLARM core software from version 6.60 to version 6.62.

#### 1090MHz Receiver Module Software

No Changes.

## G.17 AT1 Software Version 2

### G.17.1 Component Versions

---

<i>Main Module Software Version:</i>	<i>1</i>
<i>WiFi Module Software Version:</i>	<i>1</i>
<i>FLARM Module Software Version:</i>	<i>6.60</i>
<i>1090MHz Receiver Module Software Version:</i>	<i>38</i>

---

### G.17.2 Changes Since Version 1

#### Main Module Software

No Changes.

#### WiFi Module Software

No Changes.

#### FLARM Module Software

- Updated FLARM core software from version 6.40 to version 6.60.

#### 1090MHz Receiver Module Software

No Changes.

## G.18 AT1 Software Version 1

### G.18.1 Component Versions

---

<i>Main Module Software Version:</i>	1
<i>WiFi Module Software Version:</i>	1
<i>FLARM Module Software Version:</i>	6.40
<i>1090MHz Receiver Module Software Version:</i>	38

---

Environmental tests are performed in accordance with RTCA DO-160G

<i>Description</i>	<i>Section</i>	<i>Category</i>	<i>Conditions</i>
Temperature / Altitude D1	4.0	D1	
Low Ground Survival Temperature	4.5.1	D1	-55°C
Low Operating Temperature	4.5.1	D1	-40°C
High Ground Survival Temperature	4.5.2	D1	+85°C
High short Time Operating Temperature	4.5.2	D1	+70°C
High Operating Temperature	4.5.3	D1	+55°C
In Flight Loss of Cooling	4.5.4	Z	No auxiliary cooling required
Altitude	4.6.1	D1	50,000 ft
Temperature Variation	5.0	B	
Humidity	6.0	A	
Shock	7.0	B	
Vibration	8.0	U/U2	Vibration curve F/F1 (robust vibration, helicopter)
Explosion Proofness	9.0	X	not tested
Water Proofness	10.0	X	not tested
Fluids Susceptibilities	11.0	X	not tested
Sand and Dust	12.0	X	not tested
Fungus Resistance	13.0	X	not tested
Salt Spray	14.0	X	not tested
Magnetic Effect	15.0	Z	Less than 0.3m
Power Input (DC)	16.0	B	
Voltage Spike Conducted	17.0	B	
Audio Frequency Conducted Susceptibility	18.0	B	
Induced Signal Susceptibility	19.0	(X)	Compliance test pending, desired categories: AC or BC
Radio Frequency Susceptibility	20.0	T	Radiated Susceptibility
		T	Conducted Susceptibility
Emission of RF	21.0	M	Except intended operating frequencies (868/915 MHz and 2.4 GHz)
Lightning Induced Transient Susceptibility	22.0	A2XXX	
Lightning Direct Effects	23.0	X	not tested
Icing	24.0	X	not tested
Electrostatic Discharge (ESD)	25.0	A	
Fire, Flammability	26.0	X	Enclosure made of aluminium sheet and die-cast, no vent holes

Cat X: Not tested

# Notes

Room for notes



